

YAESU

AIR BAND TRANSCEIVER

FTA-750 Spirit

FTA-550 Pro-X

Operating Manual

CONTENTS

Important Notice!	1	Saving the Battery during Reception.....	43
Introduction	2	Using the Headset Microphone	44
Models, Accessories and Options	3	VOX Operation.....	44
Models	3	Side Tone Control	45
Supplied Accessories	3	Lock Function.....	46
Available Options	3	ANL Feature	48
Controls & Connectors	4	Memory Operation	49
LCD Display	8	Recalling the Memories.....	49
Before You Begin	12	Instant Storage	51
Battery Installation and Removal	12	Maintenance of the Memory.....	52
Battery Charging.....	13	Scanning Operation	55
Alkaline Battery Tray Installation	14	Scanning All Channels.....	55
Low Battery Indication.....	14	Scanning the Specified Channels.....	56
External DC Power Supply Connection	15	GPS Function (FTA-750 Only)	58
Antenna Installation.....	15	Activating the GPS Unit.....	58
Belt Clip Installation.....	16	Displaying the Position Information.....	59
Headset Connection.....	16	Memorizing the Position Information	61
Precautions.....	17	Recording the Position Information	62
Basic Operation	18	Waypoint Navigation (FTA-750 Only)	63
Reception (COM Band).....	18	Entering the Navigation (NAVI) Mode	63
Accessing the 121.5 MHz Emergency Frequency.....	21	Setting the Destination.....	64
Transmission (COM Band).....	22	SETUP Mode	67
Operation Bands	23	Basic Operation	67
Operation Modes	24	Maintenance of the Memory.....	68
Resetting the Radio.....	25	Setting of the COMM Mode Operation.....	69
Advanced Operation	27	Setting of the GPS Mode Operation (FTA-750 Only).....	72
Reception of VOR Signals.....	27	Setting of the Operation and Configuration of the Radio	77
Reception of ILS Signals.....	31	About the Radio.....	79
Split Operation.....	33	Summary of the SETUP Menu	80
Reception of Weather Channel Broadcasts.....	35	Specifications	82
Dual Watch Operation	37	Troubleshooting for Headset Connection	84
Timer Mode Operation	39		
TOT Feature.....	43		

IMPORTANT NOTICE!

FCC RF Exposure Compliance Requirements for Occupational Use Only:

The **FTA-750/FTA-550** have been tested and comply with the Federal Communications Commission (FCC) RF exposure limits for Occupational Use/Controlled Exposure Environment. In addition, both radios comply with the following Standards and Guidelines:

- FCC 96-326, Guidelines for Evaluating the Environmental Effects of Radio-Frequency Radiation.
- FCC OET Bulletin 65 Edition 97-01 (1997) Supplement C, Evaluating Compliance with FCC Guidelines for Human Exposure to Radio Frequency Electromagnetic Fields.
- ANSI/IEEE C95.1-1992, IEEE Standard for Safety Levels with Respect to Human Exposure to Radio Frequency Electromagnetic Fields, 3 kHz to 300 GHz.
- ANSI/IEEE C95.3-1992, IEEE Recommended Practice for the Measurement of Potentially Hazardous Electromagnetic Fields - RF and Microwave.
- This radio is NOT approved for use by the general population in an uncontrolled environment. This radio is restricted to occupational use, work related operations only where the radio operator must have the knowledge to control its RF exposure conditions.**
- When transmitting, hold the radio in a vertical position with its microphone 1 to 2 inches (2.5 to 5 cm) away from your mouth and keep the antenna at least 1 inch (2.5 cm) away from your head and body.**
- The radio must be used with a maximum operating duty cycle not exceeding 50%, in typical Push-to-Talk configurations. DO NOT transmit for more than 50% of total radio use time (50% duty cycle). Transmitting more than 50% of the time can cause FCC RF exposure compliance requirements to be exceeded. The radio is transmitting when the “TX” icon is displayed on the upper left corner of the screen of the radio. You can cause the radio to transmit by pressing the PTT button.**
- Always use YAESU authorized accessories.**

NOTICE

There are no user-serviceable points inside this transceiver.
All service jobs must be referred to your Authorized Service Center.

INTRODUCTION

The YAESU **FTA-750/FTA-550** are compact, stylish, solid hand-held transceivers providing communication (transmit and receive) capability on the International Aircraft Communication Band (“COM” band: 118 to 136.975 MHz), and they additionally provide VOR and ILS navigation features on the “NAV” band (108 to 117.975 MHz).

The **FTA-750/FTA-550** boast a 1.7” x 1.7” (43.2 x 43.2 mm) full dot matrix LCD displaying a plenty of information in a row. The **FTA-750/FTA-550** include NOAA weather band monitoring and 200 memory channels. The channel configurations can be easily reprogrammed in minutes using the optional PC Programming Software and your PC. In addition, the **FTA-750** provides positioning and navigation features realized by the internal GPS unit.

We recommend that you read this manual in its entirety, so as to understand the many features of the **FTA-750/FTA-550** completely. Keep this manual handy, so you may use it for reference.

Note: The VOR, ILS, and GPS navigation features of the FTA-750/FTA-550 are for supplemental aids to navigation only, and are not intended to be a substitute for accurate (primary) VOR or landing service equipment. You assume full responsibility for the use of the FTA-750/FTA-550.

Congratulations!

You now have at your fingertips a valuable communications tool, a YAESU two-way radio! Rugged, reliable and easy to use, your YAESU radio will keep you in constant touch with your friends and colleagues for years to come, with negligible maintenance or down-time.

Please take a few minutes to read this manual carefully. The information presented here will allow you to derive maximum performance from your radio, in case questions arise later on.

We’re glad you joined the YAESU team. YAESU products cover the entire spectrum of radio communications applications, and our worldwide support network is here to serve you. Let us help you get your message across.

MODELS, ACCESSORIES AND OPTIONS

Models

FTA-750L	Lithium-ion battery pack included
FTA-550L	Lithium-ion battery pack included
FTA-550 AA Battery Version	Rechargeable battery pack not included. Requires “AA” batteries for operation.

Supplied Accessories

Lithium-ion Battery Pack (7.4V)	SBR-12LI *1
AC Charger	SAD-11 *1
Charger Cradle	SBH-11 *1
Cigarette Lighter DC/DC Converter	SDD-12
Helical Antenna	SRA-13A *2
Belt Clip	SHB-11
Headset Adapter Cable	SCU-15
Alkaline Battery Tray	SBT-12
USB Cable	T9101606
Ferrite Core	L9190192
Operating Manual	
Warranty Card	

*1 These accessories are not supplied with the **FTA-550 AA Battery Version**.

*2 Antenna gain: 2.15 dBi
Impedance: 50 ohms

Available Options

SSM-10A	Speaker Microphone
SEP-10A	Earphone (available only with the SSM-10A)
YCE01	PC Programming Software

Availability of accessories may vary. Some accessories are supplied as standard per local requirements, while others may be unavailable in some regions. Consult your YAESU Dealer for details regarding these and any newly-available options.

Connection of any non-YAESU-approved accessory, should it cause damage, may void the Limited Warranty on this apparatus.

CONTROLS & CONNECTORS (TOP PANEL)

① **Antenna Jack**

This BNC connector accepts the supplied flexible antenna, or an external antenna designed to provide 50 Ω impedance on the Aircraft Communication Band.

② **VOLUME (Inner) Knob**

Turn this (inner) control clockwise to increase the volume.

③ **DIAL Selector (Outer) Knob**

This (outer) 20-position detented rotary switch tunes the operating frequency or selects the memory channels.

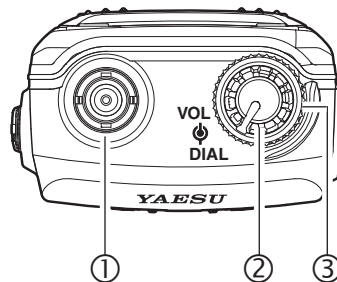

CONTROLS & CONNECTORS (FRONT PANEL)

① LCD (Liquid Crystal Display)

The display shows selected operating conditions, as indicated on Pages 8 to 11.

② Microphone

Speak into this opening in a normal voice level, while pressing the **PTT** switch, to transmit.

③ Cursor Keys and **ENT** Key

The cursor keys [◀] and [▶] are used to select an item displayed on the LCD.
Press the **ENT** key to determine the selection or entered values.

④ Control Keys

Press the **MENU** key to display the MENU screen.
Press the **BACK** key to return the display to the previous screen.
Press the **SAVE** key to store the current channel information to the memory.
Press and hold the lock key [**On**] to enable the lock feature. Controls and keys will be disabled.
Press and hold again to disable the lock feature.

⑤ **COMM** Key

Press this key to enter the COMM mode instantly.

⑥ Numeric Keypad

The keypad is used when setting frequencies.

⑦ **121.5** Key

Press and hold this key to access the emergency frequency (121.5 MHz) instantly.

⑧ Loudspeaker

The internal speaker is located in this position.

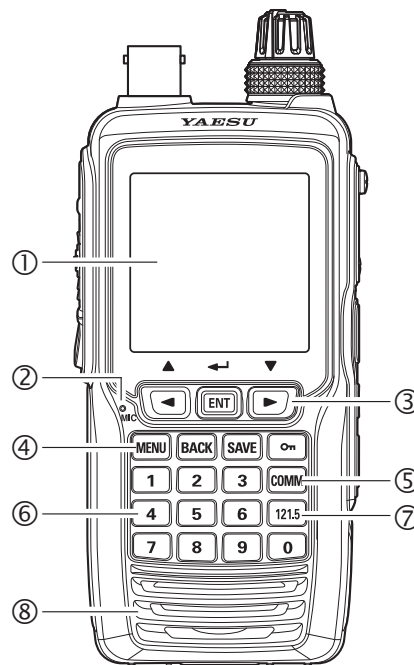

CONTROLS & CONNECTORS (LEFT SIDE)

① **POWER** Switch

Press and hold this button to turn the radio on and off.

② **PTT** (Push To Talk) Switch

Press and hold this button to transmit when you are operating in the COM band. Release this button to return to the “Receive” mode. See Page 22 for details.

③ **SQL** (Squelch) Switch

This button may be pressed to “open” the squelch manually, allowing you to listen for very weak signals. Press and hold this button for 2 seconds to “open” the squelch continuously. Press this button again to resume normal (quiet) monitoring. See Page 20 for details.

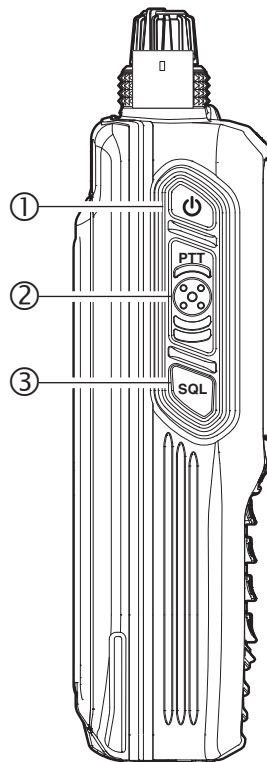

CONTROLS & CONNECTORS (RIGHT SIDE)

① MIC/SP Jack

You may connect the supplied **SCU-15** Headset Adapter Cable or the optional **SSM-10A** Speaker/Microphone to this jack. To use this jack, you must first remove the cover from the transceiver body.



Do not allow the FTA-750/FTA-550 to get wet while the cover over the MIC/SP jack is removed.

② DATA Jack

You may connect the optional USB cable to this jack. To use this jack, you must first lift the rubber cover away from the transceiver body.



Do not allow the FTA-750/FTA-550 to get wet while the rubber cover is removed.

③ EXT DC Jack

When an external 9.5- to 10.5-Volt DC power source is available, you may connect the **SDD-12** Cigarette Lighter DC/DC Converter here.



1) Do not allow the FTA-750/FTA-550 to get wet while the rubber cover is removed.

2) Do not connect any accessory unapproved by YAESU to supply DC power.

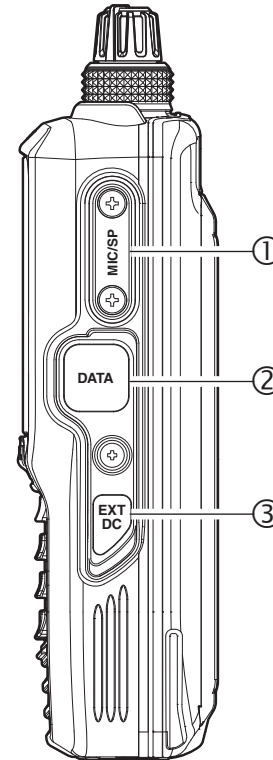

LCD DISPLAY (COM BAND)

“BUSY” icon appears during audio reception, or “TX” during transmission.

This field displays the operating frequency.

This field displays the icons indicating various statuses of the transceiver, such as “GPS on”, “Data Logger on”, “Timer on”, “Battery full”, etc.

This field displays the operation modes.

This field displays the tag name of the current channel.

This field displays the level of the audio volume or the squelch.

This field displays the channels you have previously used.



This field displays the icons indicating various statuses of functions, such as “VOX on”, “Split on”, etc.

“MEM” icon appears if the selected channel is programmed into the Scan Memory.

LCD DISPLAY (NAV BAND)

VOR CDI SCREEN

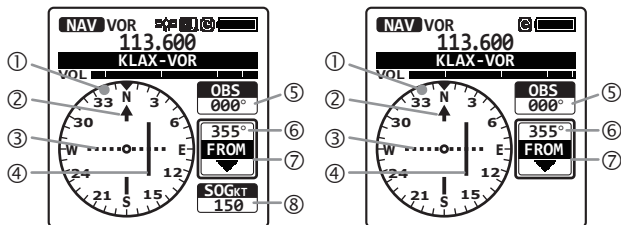

FTA-750

FTA-550

- ① Compass rose
- ② Course indicator (OBS direction)
- ③ Deviation marks
- ④ Course deviation needle
- ⑤ OBS (omni bearing selector) value
- ⑥ VOR value
- ⑦ TO/FROM indicator
- ⑧ SOG (speed over ground) value according to the GPS signal

ILS CDI SCREEN

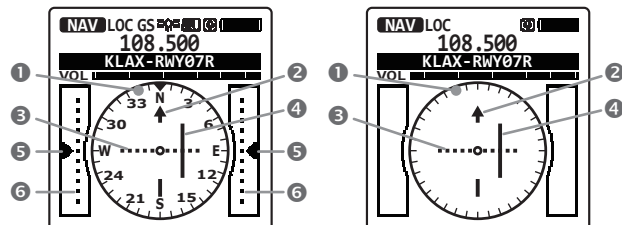

FTA-750

FTA-550

- ① Compass rose
- ② Course (runway) indicator
- ③ Deviation marks for localizer
- ④ Course deviation needle for localizer
- ⑤ Height deviation indicator for glide slope
- ⑥ Deviation marks for glide slope

LCD DISPLAY (FTA-750 ONLY)

GPS INFORMATION SCREEN

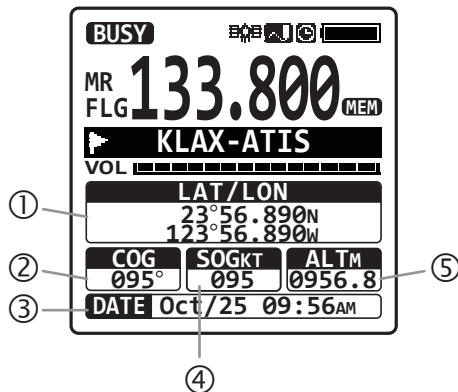

- ① Latitude and longitude values
- ② COG (course over ground) value
- ③ Date obtained from the GPS signal
- ④ SOG (speed over ground) value
- ⑤ Altitude value

GPS COMPASS SCREEN

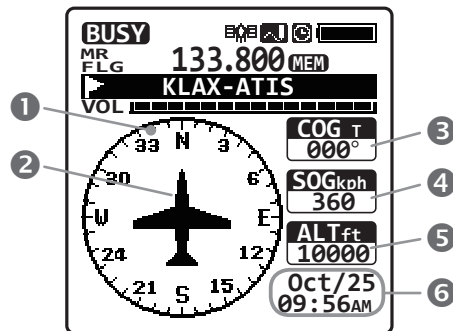

- ① Compass rose
- ② Course indicator
- ③ COG (course over ground) value
- ④ SOG (speed over ground) value
- ⑤ Altitude value
- ⑥ Date obtained from the GPS signal

LCD DISPLAY (FTA-750 ONLY)

GPS STATUS SCREEN

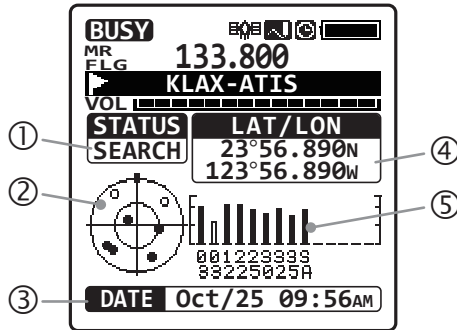

- ① GPS receiver operation status
- ② Radar scope for captured GPS satellites
- ③ Date obtained from the GPS signal
- ④ Latitude and longitude values
- ⑤ GPS signal strength indicator

WAYPOINT NAVIGATION SCREEN

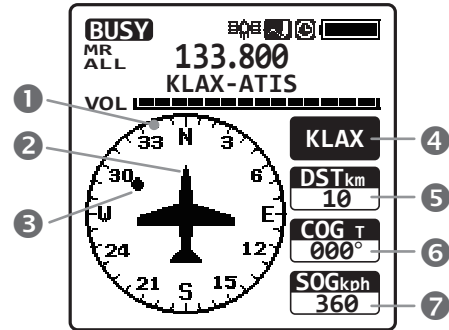

- ① Compass rose
- ② Course indicator
- ③ Destination indicator
- ④ Tag name of the destination
- ⑤ DST (distance) value
- ⑥ COG (course over ground) value
- ⑦ SOG (speed over ground) value

BEFORE YOU BEGIN

Battery Installation and Removal

- ❑ To install the battery, insert the battery pack **SBR-12LI** into the battery compartment on the back of the transceiver, press the end of the battery pack while pressing the battery pack latch on the bottom of the transceiver, then lock the pack by sliding the locking plate beside the latch until the entire “LOCK” appears.

Note:

Be sure that the rubber gasket on the **SBR-12LI** is not loose when inserting.

- ❑ To remove the battery, turn the transceiver off, slide the locking plate until the “UNLOCK” appears entirely, lift up the end of the battery pack by pressing the battery pack latch, then pull out the battery from the radio.

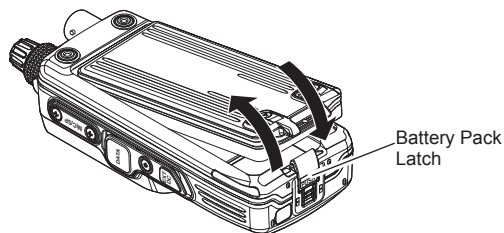

Do not attempt to open any of the rechargeable Lithium-ion packs, as personal injury or damage to the Lithium-ion pack could occur if a cell or cells become accidentally short-circuited.

Note:

To remove the battery pack after the belt clip **SHB-11** is mounted (see Page 16), lift up the clip before you press the battery pack latch.

BEFORE YOU BEGIN

Battery Charging

It is necessary to charge the Lithium-ion battery fully before its first use. Follow the procedure below:

1. Install the Lithium-ion battery pack onto the transceiver. Ensure that the transceiver is switched off.
2. Insert the cable plug of the **SAD-11** Battery Charger into the jack located on the back of the **SBH-11** Charging Cradle, then plug the **SAD-11** into the AC line outlet.

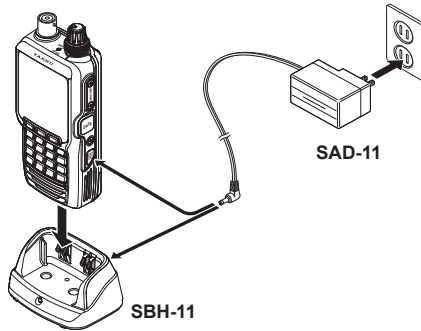

3. Insert the transceiver into the **SBH-11**; the antenna jack should be at the left side when viewing the cradle from the front.
 - You may insert the cable plug of the **SAD-11** into the **EXT DC** jack located on the right

side of the transceiver directly. In this case, the “” icon will appear in the top right corner of the LCD display.

4. If the transceiver is inserted correctly, the RED indicator on the **SBH-11** will glow.
 - A fully-discharged pack will be charged completely in 4 hours, and then the GREEN indicator on the **SBH-11** will glow.
 - It takes 8 hours for full charge with the **SAD-11** connected to the transceiver directly.

Important Notes:

- The **SAD-11** is not designed to power the transceiver for operation (transmission).
- Do not leave the charger connected to the transceiver for continuous periods in excess of 24 hours. Long term overcharging can degrade the Lithium-ion battery pack and significantly shorten its useful life.
- If using a charger other than the **SAD-11**, **SBH-11**, or if using a battery pack other than the **SBR-12LI**, follow the appropriate instructions provided with the charger/battery. Contact your Dealer if you have any doubts about the appropriateness of the particular charger or battery pack you intend to use.

BEFORE YOU BEGIN

Alkaline Battery Tray Installation

The supplied **SBT-12** Battery Tray allows operation of the **FTA-750/FTA-550** using six “AA” size alkaline battery cells.

- ❑ When installing a cell, insert the (–) end first, then press in the (+) end so the cell snaps into place. Pay attention to the polarity indicated inside the case.

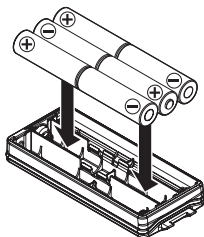

SBT-12
Alkaline Battery Tray



*The **SBT-12** must not be used with rechargeable cells. The **SBT-12** does not contain the thermal and over-current protection circuits required when utilizing Ni-Cd and Ni-MH cells.*

Note: Replace all six cells at the same time in case of low battery.

- ❑ To install the **SBT-12**, remove the Lithium-ion battery pack first from the transceiver, turn the open side of the **SBT-12** down, then insert it into the battery compartment.

Note: Be sure that the rubber gasket on the **SBT-12** is not loose when inserting.

Low Battery Indication

As your battery discharges during use, the voltage will gradually become lower. When the battery voltage reaches 6.0 Volts, the “

- Avoid recharging Lithium-ion batteries before the “Low Battery” indicator is observed, as this can degrade the charge capacity of your Lithium-ion battery pack. YAESU recommends that you carry an extra, fully-charged pack with you so you will not lose communications capability due to a depleted Lithium-ion battery.
- The fully-charged battery lasts for 12 hours on the **FTA-750** or 13.5 hours on the **FTA-550** under the conditions below:
Battery saver ... OFF
Operation ratio ... TX:RX:Standby = 6:6:48 (sec)

BEFORE YOU BEGIN

External DC Power Supply Connection

You may insert the cable plug of the optional **SDD-12** Cigarette Lighter DC/DC Converter into the **EXT DC** jack located on the right side of the transceiver. In this case, the “” icon will appear in the top right corner of the LCD display.

When making DC connections via the **SDD-12**, be absolutely certain to observe the proper voltage level and polarity guidelines.

- The **SDD-12** can be connected to 12 to 24 Volt DC power sources.

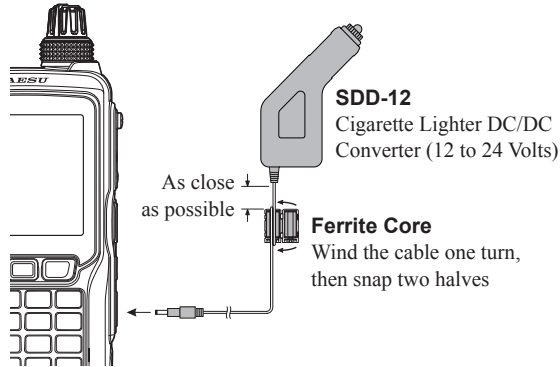

- For noise reduction from exogenous noise, wind one turn of the **SDD-12** cable around the ferrite core,

and snap its two halves together, per the illustration above. Attach the ferrite core as close as possible to the **SDD-12** body, as shown.



Do not connect any accessory unapproved by YAESU to supply DC power; otherwise the FTA-750/FTA-550 may be damaged.

Antenna Installation

- To attach the supplied antenna to the **FTA-750/FTA-550**, grasp the base of the antenna firmly, and exert a moderate “pinching” pressure on the base as you press the antenna onto the radio’s antenna connector. While exerting this pressure, rotate the antenna clockwise 1/4 turn to lock the antenna in place.

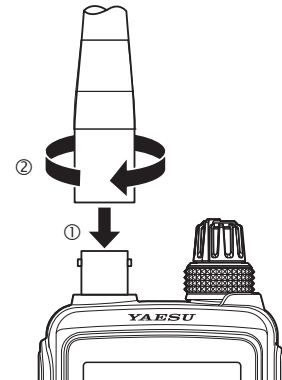

BEFORE YOU BEGIN

Belt Clip Installation

You may mount the clip to the rear of the **FTA-750/FTA-550** using the supplied screws.

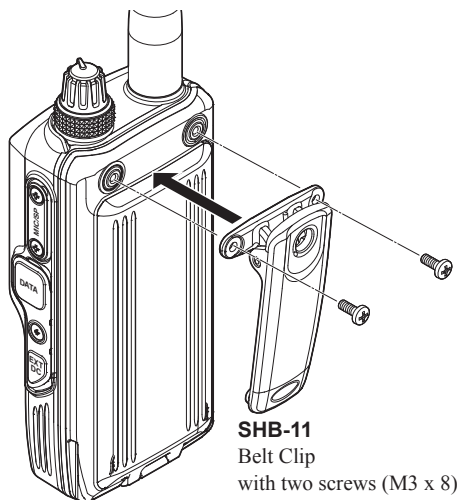

Headset Connection

You may use an optional headset through the supplied **SCU-15** Headset Adapter Cable (see also Page 84).

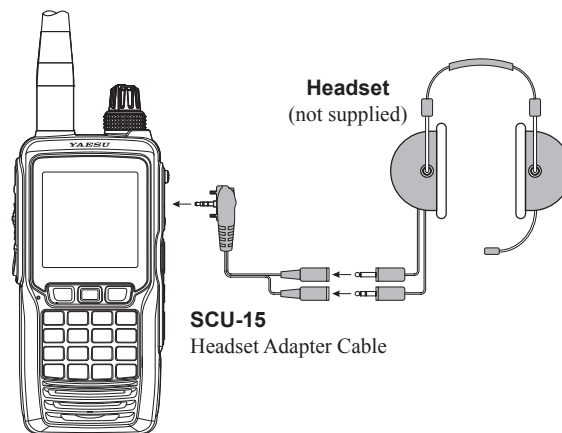

1. Remove the cover and two screws of the **MIC/SP** jack located on the right side of the transceiver.
2. Insert the plug of the **SCU-15** to the **MIC/SP** jack.
3. Fix the plug with two screws attached to the **SCU-15**.
 - Either of the plug directions are acceptable as long as the both screws fit the screw holes.
4. Insert the plugs of the headset to the sockets of the **SCU-15**.

BEFORE YOU BEGIN

Precautions

- The **FTA-750/FTA-550** are capable of two-way communication on channels used for critical aviation safety communications. Therefore, it is important that this radio be kept away from children or other unauthorized users at all times.
- Do not dispose of the Lithium-ion battery pack in a fire. Do not carry a Lithium-ion battery pack in your pocket, where keys or coins could short the terminals. This could create a serious fire/burn danger, and possibly cause damage to the Lithium-ion pack.
- The **FTA-750/FTA-550** are designed to have the waterproof capability equivalent to IPX5. Do not allow the radio to become submerged, and do not subject it to water spray under pressure.

BASIC OPERATION

Reception (COM Band)

Turning the radio on and off

- ❑ *To turn the radio on,* press and hold the **POWER** switch. “WARNING” will be displayed.

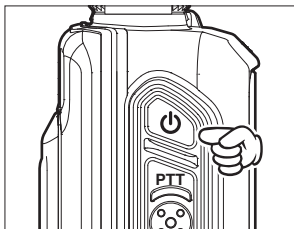

- ❑ If you agree with the warning message, press the [ENT] key.

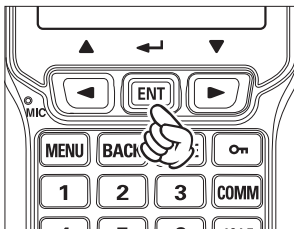

- ❑ A channel frequency will appear on the display. If not, press the [COMM] key.

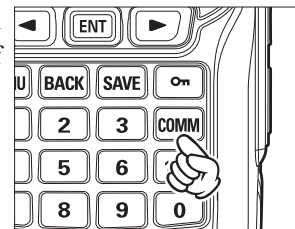

- ❑ The “**BUSY**” icon appears on the display when the audio signal is received on the current frequency.

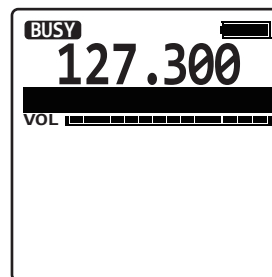

- ❑ *To turn the radio off,* press and hold the **POWER** switch.

BASIC OPERATION

Adjusting the frequency

- ❑ You may turn the **DIAL** selector (outer) knob on the top panel to choose the desired operating frequency. The channel frequency will appear on the LCD.

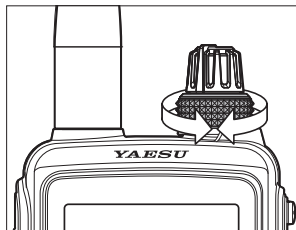

- ❑ Directly entering frequencies from the keypad is the easiest method if you know the frequency on which you wish to operate. Just enter the five digits of the frequency to move to that frequency.

For example, to set 134.35 MHz,
press [1] → [3] → [4]
→ [3] → [5].

To set 118.275 MHz,
you do not need to
press the final "5" in the
frequency as below:

[1] → [1] → [8] → [2]
→ [7].

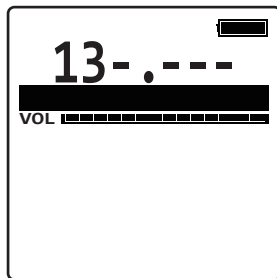

- ❑ You may recall the operating frequency that you have used by pressing the [ENT] key. A list of frequencies you have used will appear below the VOL meter on the display.

Select the desired frequency by pressing the [◀] or [▶] key, then press the [ENT] key.

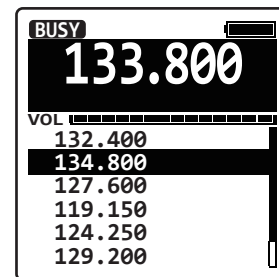
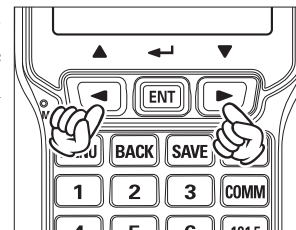

BASIC OPERATION

Adjusting the volume

- ❑ Rotate the **VOL** (inner) knob to set the volume level. If no signal is present, press the **SQL** switch; background noise will now be heard, and you may use this noise to set the **VOL** knob for the desired audio level. Press and hold the **SQL** switch to silence the noise and resume normal (quiet) monitoring.

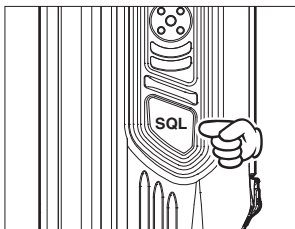
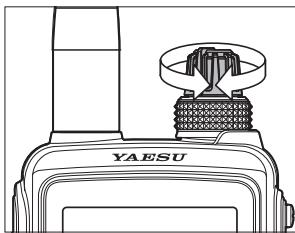

Adjusting the squelch

- ❑ Press the **SQL** switch, then rotate the **DIAL** selector knob to set the squelch threshold (0 to 15) so that the receiver is just silenced. A higher number indicates that a higher signal level is required in order to open the squelch.

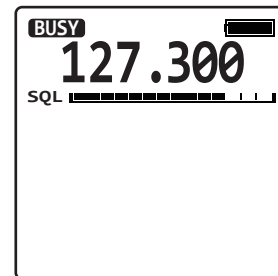
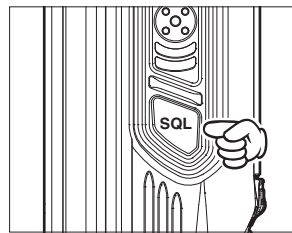

- ❑ Press and hold the **SQL** switch to set the squelch threshold to 0 (off).
- ❑ Your new setting will be saved each time you perform either of the operations above.

BASIC OPERATION

Monitor Switch

When listening to a very weak signal from an aircraft or ground station, you may observe the signal disappearing periodically as the incoming signal strength becomes too weak to override the squelch threshold setting.

To disable the squelch temporarily, press and hold the **SQL** switch for 2 seconds. The squelch will remain open and you should have a better chance of hearing weak signals.

To return to normal operation, press the **SQL** momentarily.

Accessing the 121.5 MHz Emergency Frequency

The **FTA-750/FTA-550** can quickly access the 121.500 MHz emergency frequency. This function can be activated even when the keypad lock function (described on Page 46) is in use.

- ❑ To access the emergency frequency, press and hold the [121.5] key. After four beeps, the transceiver enters the emergency mode and the frequency is automatically tuned to 121.500 MHz.

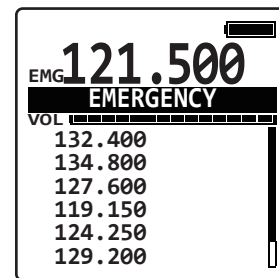
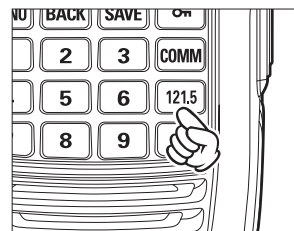

- ❑ To exit the emergency mode, press the [COMM] key. The message confirming the cancellation of the emergency mode will appear. Press the [◀] or [▶] key to select "YES", then press the [ENT] key.

BASIC OPERATION

Transmission (COM Band)

- ❑ To transmit, press and hold the **PTT** switch. Speak into the microphone area of the front panel grille in a normal voice level.

The “**TX**” icon, which indicates that the **FTA-750/FTA-550** are in the transmit mode, appears on the display.

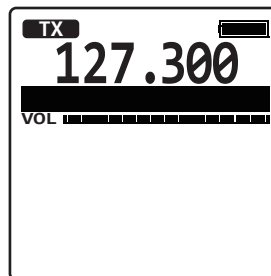
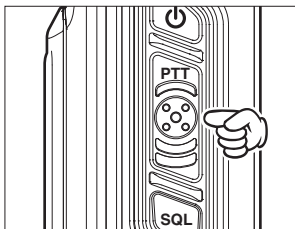

- ❑ To return to the receive mode, release the **PTT** switch.

Operating Advice: Use of Internal Microphone

Your **FTA-750/FTA-550** are sealed against water ingress, which includes waterproof seals around the microphone and speaker enclosure. This requires that you focus your speech in the direction of the microphone's location, so as to ensure sufficient voice input to the radio. Refer to the illustration and observe the location of the internal microphone.

If you find it difficult to utilize the **FTA-750/FTA-550** conveniently and safely while speaking directly into the microphone, we recommend the use of the **SSM-10A** Speaker/Microphone (option), or an aftermarket aviation headset with boom microphone.

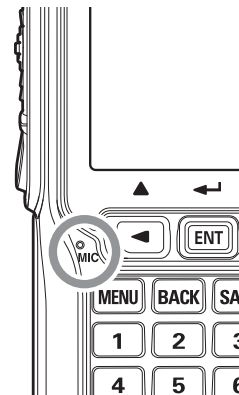

BASIC OPERATION

Operation Bands

When the **FTA-750/FTA-550** are turned on for the first time, it enters the COMM mode and displays the COM band screen. The COMM mode is the basic operation mode of the **FTA-750/FTA-550** that allows you to tune through either of the NAV and COM bands using the **DIAL** knob or the keypad.

- **NAV band (108.000 - 117.975 MHz):**
Band for navigation utilizing data signals emitted by VOR (VHF omnidirectional range) stations and ILS (instrument landing system) of airports.
- **COM band (118.000 - 136.975 MHz):**
Band for communication utilizing audio signals.

When the **FTA-750/FTA-550** receive a data signal associated with VOR or ILS, the display will automatically switch to the NAV band screen which shows a CDI (course deviation indicator) based on the received signal, and “**NAV**”, which indicates that the **FTA-750/FTA-550** are on the NAV band, appears on the display.

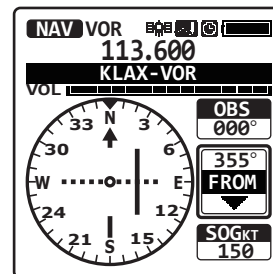

When receiving a VOR signal on the FTA-750

BASIC OPERATION

Operation Modes

The **FTA-750/FTA-550** operate in either of the modes below. You can switch the modes via the MENU screen displayed by pressing the [MENU] key on the front panel.

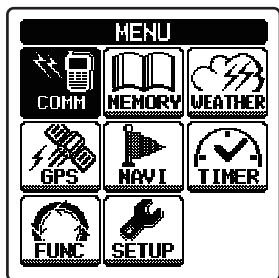
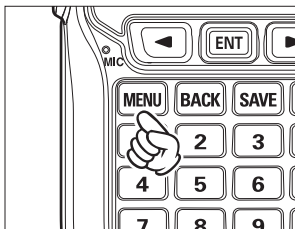

FTA-750

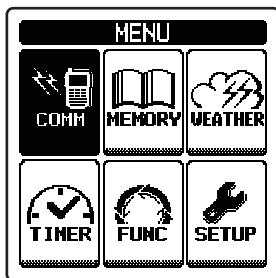

FTA-550

When turning on the **FTA-750/FTA-550**, the last mode you have used before turning off will automatically be entered.

- **COMM**
The basic operating mode for communication. Navigation through the NAV band is also performed on this mode.
- **MR (MEMORY)**
This mode provides you with the ability to store and recall as many as 200 channels in the radio's main memory bank.
- **WX (WEATHER)**
The receive mode for the VHF weather channel broadcasts. 10 weather channels are pre-programmed at the factory.
- **GPS (FTA-750 only)**
The position information and status of the GPS satellites according to the signals received by the built-in GPS unit are displayed during this mode.
- **NAVI (FTA-750 only)**
Navigation to the waypoint (destination) memorized or manually input is carried out in this mode.
- **SETUP**
This mode allows certain aspects of your radio's configuration to be customized for your personal operating conditions.

BASIC OPERATION

Convenient menu items

The MENU screen also includes the following items which provide advanced and convenient usage of the **FTA-750/FTA-550**.

○ TIMER

You may use the **FTA-750/FTA-550** as a count-down timer or a stopwatch through this menu.

○ FUNCTION

Enables and disables various functions such as scan and dual watch features through this menu.

Resetting the Radio

To clear all memories and other settings to factory defaults:

1. Press the **[MENU]** key to display the MENU screen.
2. Select “SETUP” on the screen by pressing the [**◀**] or [**▶**] key, and then press the **[ENT]** key.

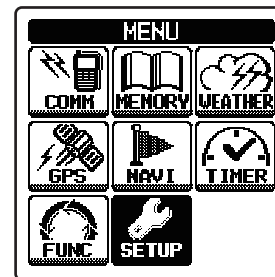

3. Select “CONFIGURATION” on the screen by pressing the [**◀**] or [**▶**] key, and then press the **[ENT]** key.

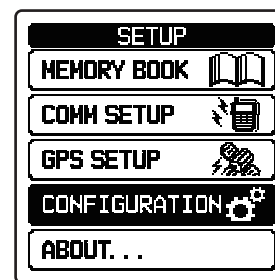

BASIC OPERATION

4. Select “RESET” on the screen by pressing the [◀] or [▶] key, and then press the [ENT] key.

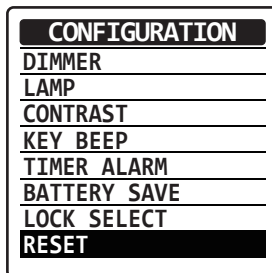

5. Select “FACTORY” on the screen by pressing the [◀] or [▶] key, and then press the [ENT] key.

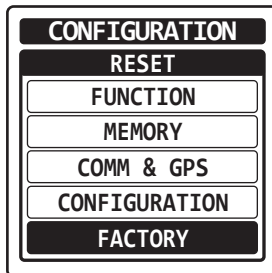

6. Select “OK?” on the screen by pressing the [◀] or [▶] key, and then press the [ENT] key.

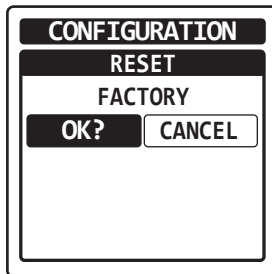

The initialization will start and then “COMPLETED!” will be displayed after the radio returns to factory default.

ADVANCED OPERATION

Reception of VOR Signals

When the **FTA-750/FTA-550** receive a VOR (VHF omnidirectional range) signal, the display will automatically switch to the NAV band screen which shows a CDI (course deviation indicator) based on the received signal, and “**VOR**”, which indicates that the **FTA-750/FTA-550** are receiving the VOR signal, appears on the display.

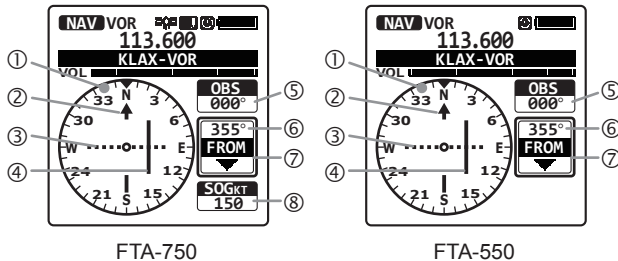

- ① Compass rose
- ② Course indicator (OBS direction)
- ③ Deviation marks
- ④ Course deviation needle
- ⑤ OBS (omni bearing selector) value
- ⑥ VOR value
- ⑦ TO/FROM indicator
- ⑧ SOG (speed over ground) value according to the GPS signal

- The OBS is set to 0 degree when you use the **FTA-750/FTA-550** for the first time.
The last value you have set as the OBS will be displayed next time the NAV band screen appears.
- The upside of the compass rose always indicates the direction set as the OBS.
- When the OBS is set to a degree within the “TO” range relative to the VOR signal, the **FTA-750/FTA-550** displays a degree adding (or subtracting) 180° to (or from) the VOR signal as the VOR value.
- The SOG is displayed only when the internal GPS unit is activated and receives a fix in the **FTA-750**.

Note:

You may change the COM band receive frequency while receiving a VOR signal. If the [ENT] key is pressed during the tag name of the VOR station is selected, the recall screen listing the frequencies you have used will temporarily appear on the display, so that you may select a frequency from the list with the [◀] or [▶] key or change the frequency with the **DIAL** selector knob.

ADVANCED OPERATION

Reading the CDI

- If the OBS is set to 50° and your aircraft is at 230° from a certain VOR station, for example, you are “on course” and the course deviation needle of the CDI will be at the center of the compass rose.

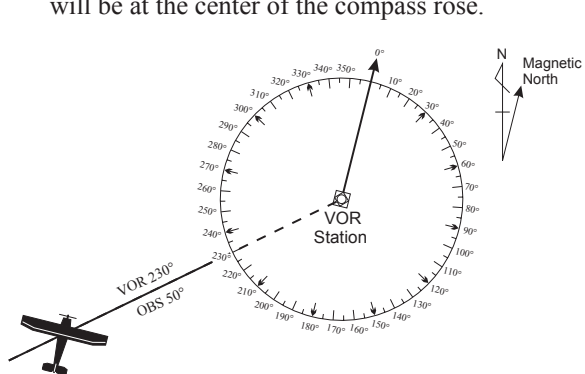

- If the OBS is set to 50° but your aircraft is at 236° from a certain VOR station, for example, you are “off course” and the course deviation needle of the CDI will be inside the right half of the compass rose.

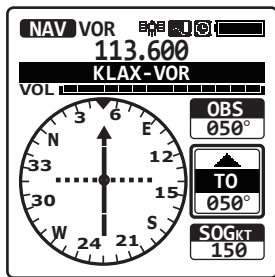
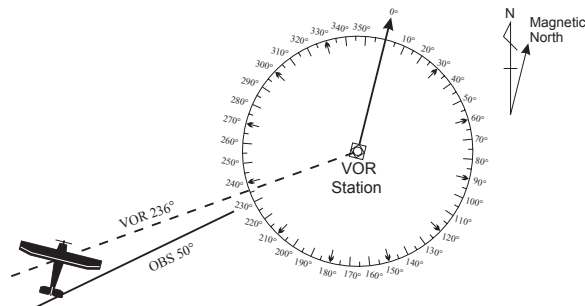

FTA-750

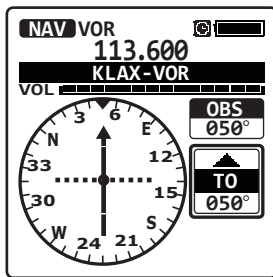

FTA-550

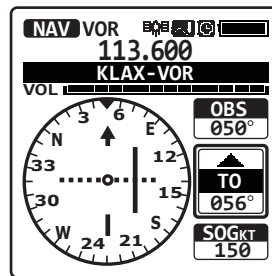

FTA-750

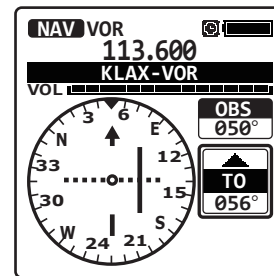

FTA-550

ADVANCED OPERATION

- The course deviation needle moves to the right if your aircraft is off course to the left of the OBS, or moves to the left if your aircraft is off course to the right of the OBS.
- The deviation marks indicate off-course level by 2 degrees up to 10 degrees per each side. If your deviation exceeds 10 degrees, the course deviation needle will stay at the position of the fifth mark (the end of the scale) of the left or right side.

Flying to a VOR station

1. Set the frequency to the desired VOR station.
2. Press the [◀] or [▶] key to select “OBS” on the screen.

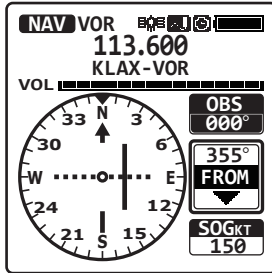

FTA-750

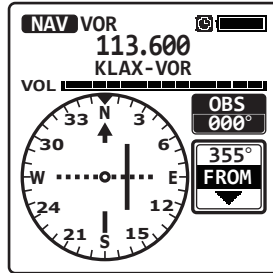

FTA-550

3. Enter the course to the VOR station with the keypad or the **DIAL** knob.

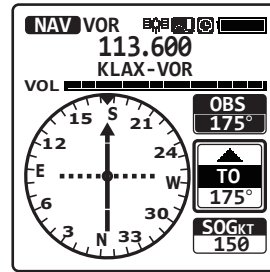

FTA-750

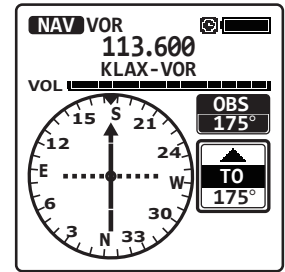

FTA-550

4. Correct your course until the course deviation needle on the screen is at the center of the compass rose.

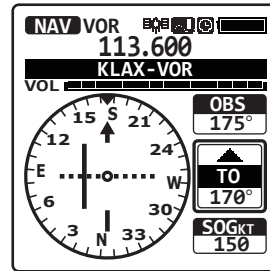

FTA-750

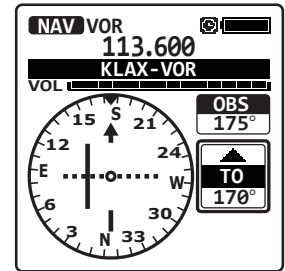

FTA-550

ADVANCED OPERATION

Flying to a desired course

If you know the direction of your destination from a specific VOR station, you may use the CDI to correct your course of flying.

1. Set the frequency to the desired VOR station.
2. Press the [◀] or [▶] key to select “OBS” on the screen.

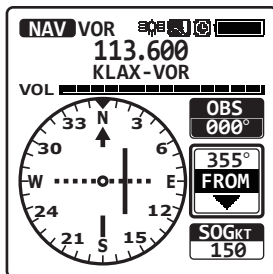

FTA-750

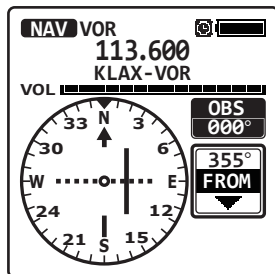

FTA-550

3. Enter the course from the VOR station with the keypad or the **DIAL** knob.
4. Correct your course until the course deviation needle on the screen is at the center of the compass rose.

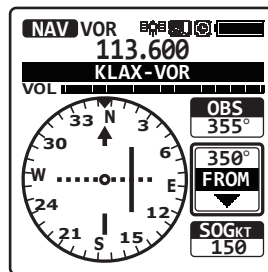

FTA-750

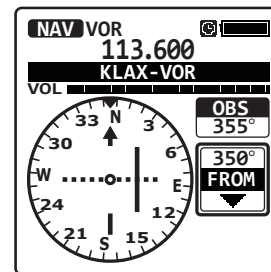

FTA-550

ADVANCED OPERATION

Reception of ILS Signals

When the **FTA-750/FTA-550** receive an ILS (instrument landing system) signal, the display will automatically switch to the NAV band screen which shows a CDI (course deviation indicator) based on the received signal, and “**LOC**”, which indicates that the **FTA-750/FTA-550** are receiving the localizer signal, and “**GS**”, which indicates that the **FTA-750** is receiving the glide slope signal, appear on the display.

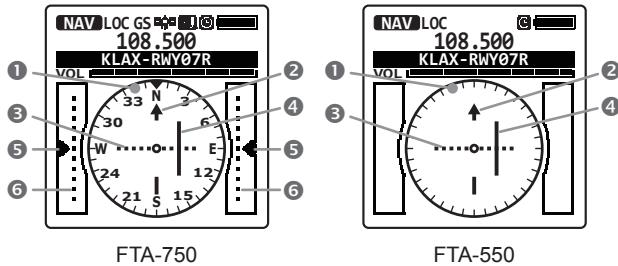

- ① Compass rose
- ② Course (runway) indicator
- ③ Deviation marks for localizer
- ④ Course deviation needle for localizer
- ⑤ Height deviation indicator for glide slope
- ⑥ Deviation marks for glide slope

- In the **FTA-750** when the internal GPS unit is not activated or cannot receive a fix even it is activated, or in the **FTA-550**, the upside of the compass rose always indicates the direction of the runway and no sign indicating the bearings is displayed on the compass rose.
- In the **FTA-750** when the internal GPS unit is activated and receives a fix, the compass rose rotates to display the approaching course up. The course indicator, deviation marks, and deviation needle also rotate to display the runway direction if registered in advance.

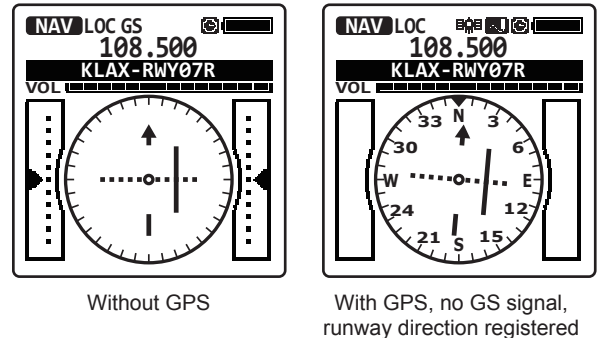

ADVANCED OPERATION

Note:

You may change the COM band receive frequency while receiving an ILS signal. If the [ENT] key is pressed while the tag name of the airport is selected, the recall screen listing the frequencies you have used will temporarily appear on the display, so that you may select a frequency from the list with the [◀] or [▶] key or change the frequency with the **DIAL** selector knob.

Terminology:

- The localizer signal guides the approach to the runway in horizontal direction.
- The glide slope signal guides the approach to the runway in vertical direction. Note that some airports are unequipped with the glide slope.

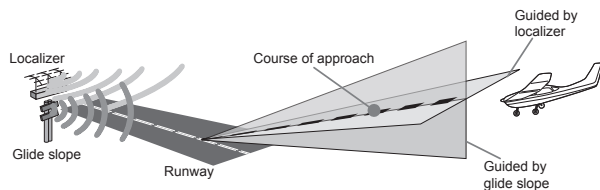

Reading the CDI

- The course deviation needle moves to the right if your aircraft is off course to the left of the runway, or moves to the left if your aircraft is off course to the right of the runway.
- The height deviation indicator moves up if your aircraft flies lower than the ideal altitude, or moves down if your aircraft flies higher than the ideal altitude.

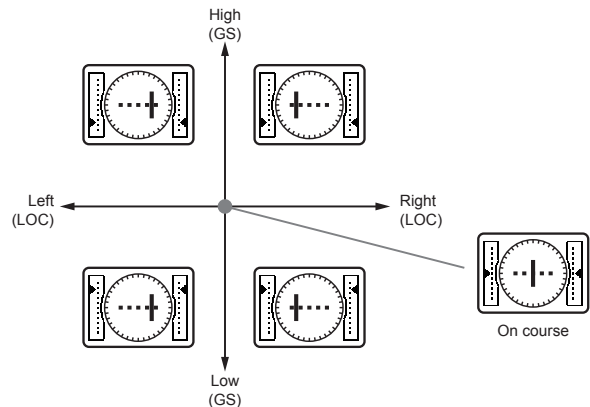

CDI Examples Corresponding to Aircraft Location
(Runway is to be at the back of the screen)

ADVANCED OPERATION

Split Operation

The split operation feature allows you to transmit a call to a flight service station using the COM band frequencies, while receiving a station in the NAV band. VOR stations equipped with this capability typically are shown, on navigation charts, with the voice calling frequency in parenthesis above the navigation frequency.

Programming a transmit frequency

1. Press the [MENU] key to display the MENU screen.
2. Select “SETUP” on the screen by pressing the [◀] or [▶] key, and then press the [ENT] key.

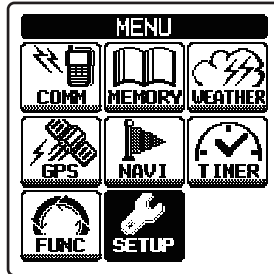

3. Select “COMM SETUP” on the screen by pressing the [◀] or [▶] key, and then press the [ENT] key.



4. Select “SPLIT FREQUENCY” on the screen by pressing the [◀] or [▶] key, and then press the [ENT] key.

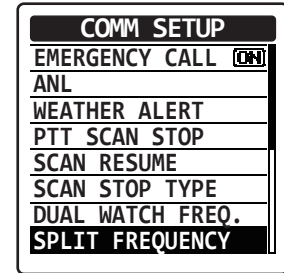

5. Enter the transmit frequency with the keypad.

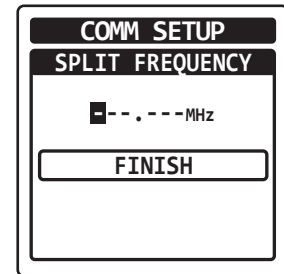

ADVANCED OPERATION

- Select “FINISH” on the screen by pressing the [◀] or [▶] key, and then press the [ENT] key.

The frequency will be determined and the display will return to the COMM SETUP menu.

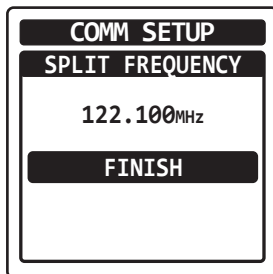

Note:

Only the COM band frequencies can be set as the transmit frequency.

Activating the split mode

- Press the [MENU] key to display the MENU screen.
- Select “FUNC” on the screen by pressing the [◀] or [▶] key, and then press the [ENT] key.

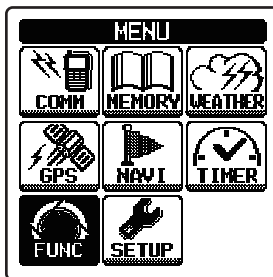

- Select “SPLIT” on the screen by pressing the [◀] or [▶] key, and then press the [ENT] key.

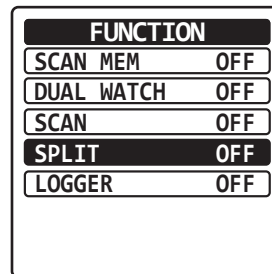

- If “ON” is displayed in the right hand of “SPLIT”, the **FTA-750/FTA-550** are already in the split mode.

The display will return to the previous screen and the “±” icon, which indicates that the **FTA-750/FTA-550** are in the split mode, will appear on the display.



ADVANCED OPERATION

Operating in the split mode

- ❑ To transmit a voice call during the NAV band reception, press and hold the **PTT** switch, and speak into the microphone. The COM band screen will be displayed with the frequency you have set.
- ❑ To exit the split mode, select “SPLIT” and press the [ENT] key in the FUNCTION menu.

FUNCTION	
SCAN MEM	OFF
DUAL WATCH	OFF
SCAN	OFF
SPLIT	ON
LOGGER	OFF

Reception of Weather Channel Broadcasts

The **FTA-750/FTA-550** can receive VHF weather channel broadcasts, which may assist your flight planning. The **FTA-750/FTA-550** include a special bank capable of storing 10 weather channels, which simplifies access when you are in an unfamiliar location.

- ❑ To receive weather channels, press the [MENU] key, select “WEATHER” on the screen by pressing the [◀] or [▶] key, and then press the [ENT] key.

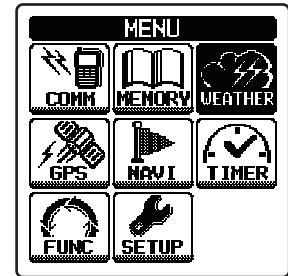

The last channel you have tuned will be received.

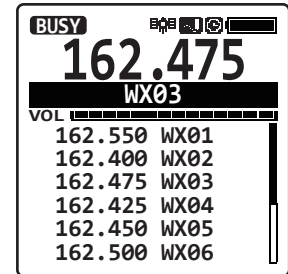

ADVANCED OPERATION

- ❑ You can also select a weather channel from the pre-programmed list with the **DIAL** selector knob.

To confirm the weather channel frequency selection, press the [ENT] key.

- ❑ To exit the WX mode, press the [MENU] key, select the mode other than “WEATHER” on the screen by pressing the [◀] or [▶] key, and then press the [ENT] key.

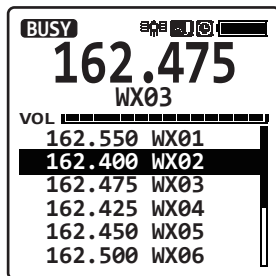

Weather alert reception

In the event of extreme weather disturbances, such as storms and hurricanes, the NOAA (National Oceanic and Atmospheric Administration) sends a weather alert accompanied by a 1050 Hz tone and subsequent weather report on one of the NOAA weather channels.

When the radio receives the weather alert on the operating frequency, it displays a warning as below on the screen and continues to make alarm sounds until either of the keys is pressed.



You may enable or disable the alarm function when receiving the weather alert signal via the COMM SETUP menu, if desired. See Page 69 for details.

ADVANCED OPERATION

Dual Watch Operation

The dual watch feature automatically checks for activity on the P-ch (priority channel) set via the COMM SETUP menu while you are operating on another channel. During the dual watch operation, the current channel and the P-ch will be polled alternately for a 200 ms interval.

Setting the P-ch

1. Press the [MENU] key to display the MENU screen.
2. Select “SETUP” on the screen by pressing the [◀] or [▶] key, and then press the [ENT] key.

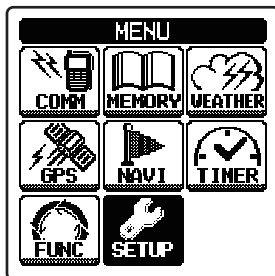

3. Select “COMM SETUP” on the screen by pressing the [◀] or [▶] key, and then press the [ENT] key.

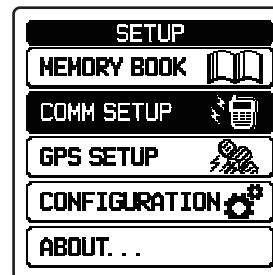

4. Select “DUAL WATCH FREQ.” on the screen by pressing the [◀] or [▶] key, and then press the [ENT] key.

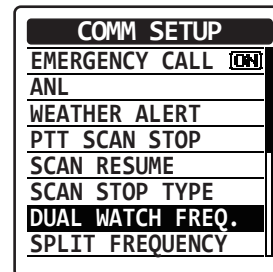

5. Enter the frequency you want to poll, with the keypad.

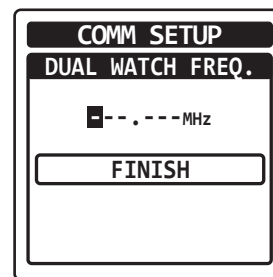

ADVANCED OPERATION

6. Select “FINISH” on the screen by pressing the [◀] or [▶] key, and then press the [ENT] key.

The frequency will be determined and the display will return to the COMM SETUP menu.

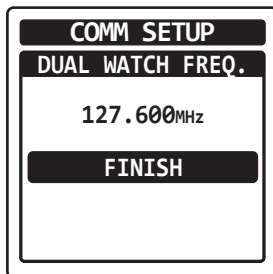

Starting the dual watch

1. Press the [MENU] key to display the MENU screen.
2. Select “FUNC” on the screen by pressing the [◀] or [▶] key, and then press the [ENT] key.

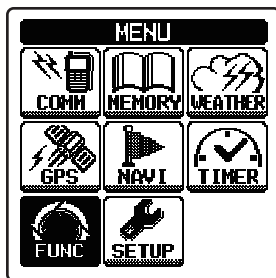

3. Select “DUAL WATCH” on the screen by pressing the [◀] or [▶] key, and then press the [ENT] key.

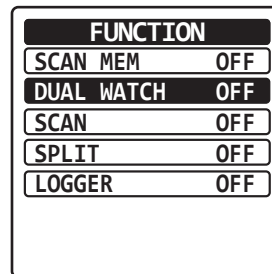

- If “ON” is displayed in the right hand of “DUAL WATCH”, the **FTA-750/FTA-550** are performing the dual watch.

The display will return to the previous screen and the “**DW**” icon, which indicates that the **FTA-750/FTA-550** are performing the dual watch, will appear on the display.

- When the radio encounters a signal in the current channel, it still polls both channels alternately with longer staying time on the current channel.
- When the radio encounters a signal in the P-ch, the radio stays on the P-ch until the signal disappears, and the frequency indication on the display blinks. After the signal disappears, the dual watch resumes.

ADVANCED OPERATION

- ❑ To stop the dual watch, select “DUAL WATCH” and press the [ENT] key in the FUNCTION menu.

FUNCTION	
SCAN MEM	OFF
DUAL WATCH	ON
SCAN	OFF
SPLIT	OFF
LOGGER	OFF

Timer Mode Operation

The **FTA-750/FTA-550** both provide a “Stopwatch” timer and a “Countdown” timer. These can be used for a variety of time-keeping purposes.

Even while the timer is in operation, you can move to the other operation modes to receive, transmit, scan, etc.

Using the stopwatch timer

1. Press the [MENU] key to display the MENU screen.
2. Select “TIMER” on the screen by pressing the [◀] or [▶] key, and then press the [ENT] key.
3. Select “STOPWATCH” on the screen by pressing the [◀] or [▶] key, and then press the [ENT] key.

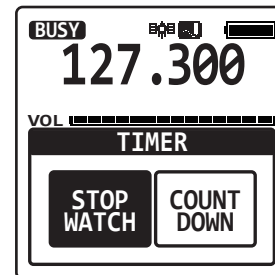
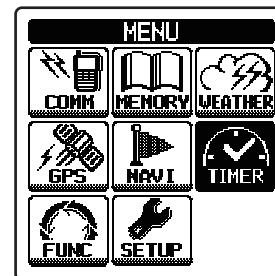

ADVANCED OPERATION

4. To start the counting, select “START” on the screen by pressing the [◀] or [▶] key, and then press the [ENT] key.

The displayed time will increase and “START” changes to “STOP”.

The “🕒” icon appears on the top right of the display while counting.

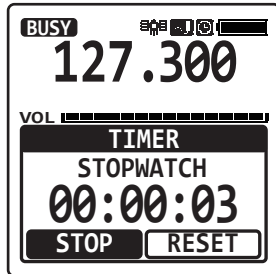
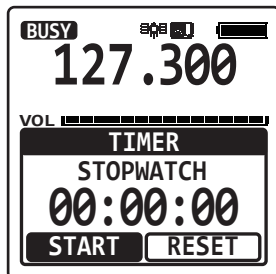

5. To stop the counting, select “STOP” and press the [ENT] key.

To resume the counting, select “START” changed from “STOP” and press the [ENT] key again.



6. To clear the count, select “RESET” on the screen by pressing the [◀] or [▶] key, and then press the [ENT] key.

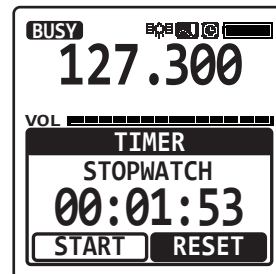

If “RESET” is selected while counting, the timer will continue to count from “00:00:00”.

If “RESET” is selected while stopping, the displayed time will be changed to “00:00:00” and the timer will keep stopping.

Note:

You may change the receive frequency while counting. Select the tag name field with the [◀] or [▶] key, then press the [ENT] key to display the recall screen listing the frequencies you have used temporarily on the display, so that you may select a frequency from the list with the [◀] or [▶] key or change the frequency with the **DIAL** selector knob.

ADVANCED OPERATION

Using the countdown timer

1. Press the [MENU] key to display the MENU screen.
2. Select “TIMER” on the screen by pressing the [◀] or [▶] key, and then press the [ENT] key.
3. Select “COUNTDOWN” on the screen by pressing the [◀] or [▶] key, and then press the [ENT] key.

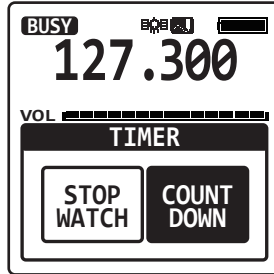

4. Input the time with the keypad or the DIAL selector knob, and then press the [ENT] key. Press the [◀] or [▶] key to move the cursor to hour, minute, or second. Press the [BACK] key to cancel the input time.



5. To start the counting, select “START” on the screen by pressing the [◀] or [▶] key, and then press the [ENT] key.

The displayed time will decrease and “START” changes to “STOP”.

The “🕒” icon appears on the top right of the display while counting.



6. To stop the counting, select “STOP” and press the [ENT] key.

To resume the counting, select “START” changed from “STOP” and press the [ENT] key again.



ADVANCED OPERATION

7. To clear the count, select “RESET” on the screen by pressing the [◀] or [▶] key, and then press the [ENT] key.

The displayed time will be changed to “00:00:00” and the timer will stop.

Note:

You may change the receive frequency while counting. Select the tag name field with the [◀] or [▶] key, then press the [ENT] key to display the recall screen listing the frequencies you have used temporarily on the display, so that you may select a frequency from the list with the [◀] or [▶] key or change the frequency with the **DIAL** selector knob.



- When the countdown timer reaches “00:00:00”, the beeps will continuously sound and “Timer Alarm!” will be displayed on the screen. Press any key to stop the beeps.

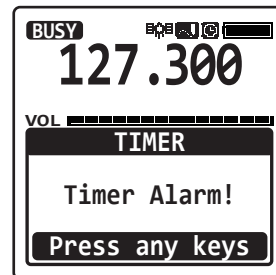

- You can set the timer to alarm without beeps. Select “OFF” on the item “TIMER ALARM” of the CONFIGURATION menu in the SETUP mode.

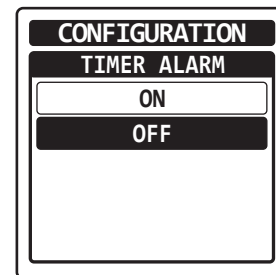
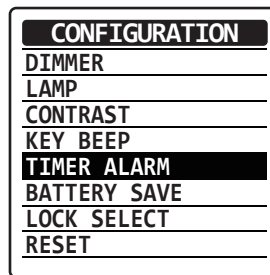

ADVANCED OPERATION

TOT Feature

The TOT (time-out timer) shuts off the transceiver after continuous transmission exceeds the programmed time. This feature prevents unintended transmission by mistake and reduces battery consumption.

To activate the TOT, select either of “1min”, “2min”, “3min”, “5min” on the item “TX TOT” of the COMM SETUP menu in the SETUP mode.

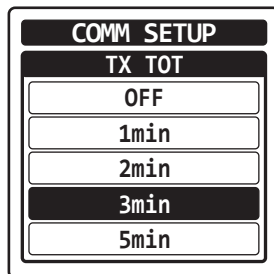
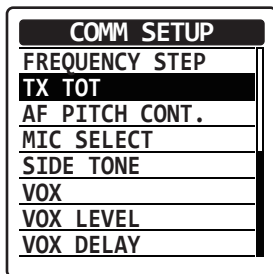

Saving the Battery during Reception

One of the important features of the **FTA-750/FTA-550** are its battery saver, which “puts the radio to sleep” for a time interval, periodically “waking it up” to check for activity. If somebody is talking on the channel, the **FTA-750/FTA-550** will remain in the “awake” mode, then resume its “sleep” cycles. This feature significantly reduces quiescent battery drain.

To activate the battery saver, select one of the following interval time ratios on the item “BATTERY SAVE” of the CONFIGURATION menu in the SETUP mode.

- 50% ... Sleeps for 100 ms after 100 ms awake
- 70% ... Sleeps for 250 ms after 100 ms awake
- 80% ... Sleeps for 450 ms after 100 ms awake
- 90% ... Sleeps for 900 ms after 100 ms awake

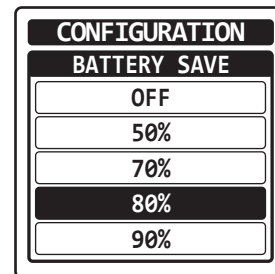
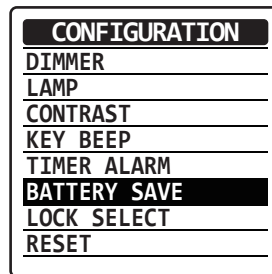

ADVANCED OPERATION

Using the Headset Microphone

If you want to use the microphone of an aviation headset prepared by yourself, change the assignment of microphone controlled with the **PTT** switch.

To assign the headset microphone, select “EXT MIC” on the item “MIC SELECT” of the COMM SETUP menu in the SETUP mode.

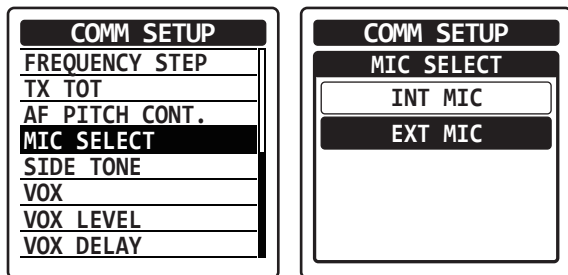

When an optional aviation headset is connected, the **PTT** switch on the radio will activate the headset microphone for transmission.

Note:

If you find it difficult to use the **PTT** switch of the radio, we recommend to use an aftermarket external PTT switch. See also Page 84 for details.

VOX Operation

If you want to have both hands free, use a headset and activate the VOX (voice-actuated transmit/receive switching) system.

Notes:

- The VOX system does not function when using just the internal microphone; an external headset must be used.
- Do not activate the VOX system when connecting the optional microphone **SSM-10A**.
- To activate the VOX system, select “ON” on the item “VOX” of the COMM SETUP menu in the SETUP mode.

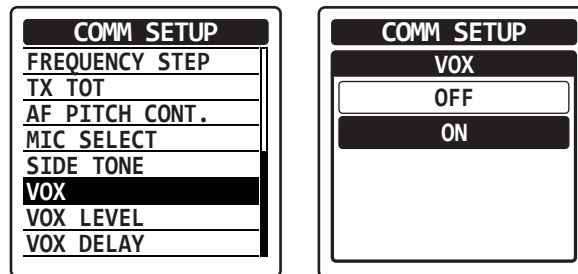

The “**V**” icon, which indicates that the VOX system is active, will appear at the right side of the channel frequency when the display returns to the COM band screen.

ADVANCED OPERATION

- ❑ To adjust the VOX gain, select one of the following gain levels on the item “VOX LEVEL” of the COMM SETUP menu in the SETUP mode.

MIN / LEVEL 1 /
LEVEL 2 / LEVEL 3 /
MAX

COMM SETUP
VOX LEVEL
MIN
LEVEL1
LEVEL2
LEVEL3
MAX

- ❑ To set the VOX delay, select one of the following times on the item “VOX DELAY” of the COMM SETUP menu in the SETUP mode.

0.5sec / 1.0sec /
1.5sec / 2.0sec /
3.0sec

COMM SETUP
VOX DELAY
0.5sec
1.0sec
1.5sec
2.0sec
3.0sec

Side Tone Control

When utilizing an external headset, you may monitor your own voice talking to the microphone through the headphone.

Note:

Do not activate the side tone function when connecting the optional microphone **SSM-10A**.

- ❑ To activate the monitoring of your voice (side tone), select one of the following side tone level on the item “SIDE TONE” of the COMM SETUP menu in the SETUP mode.

MIN/LEVEL1/LEVEL2/MAX

COMM SETUP
FREQUENCY STEP
TX TOT
AF PITCH CONT.
MIC SELECT
SIDE TONE
VOX
VOX LEVEL
VOX DELAY

COMM SETUP
SIDE TONE
OFF
MIN
LEVEL1
LEVEL2
MAX

- ❑ To change the side tone level temporarily during the monitoring, rotate the **DIAL** selector knob when pressing and holding the **PTT** switch.

ADVANCED OPERATION

Lock Function

This function prevents accidental changes to the frequency setting and the keypad controls.

Setting the lockout configuration

You may choose the controls to be locked.

1. Press the **[MENU]** key to display the MENU screen.
2. Select "SETUP" on the screen by pressing the [**◀**] or [**▶**] key, and then press the **[ENT]** key.
3. Select "CONFIGURATION" on the screen by pressing the [**◀**] or [**▶**] key, and then press the **[ENT]** key.
4. Select "LOCK SELECT" on the screen by pressing the [**◀**] or [**▶**] key, and then press the **[ENT]** key.

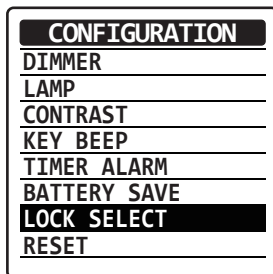

5. Select one of the following lock configuration by pressing the [**◀**] or [**▶**] key, and then press the **[ENT]** key.
KEY LOCK /
DIAL LOCK /
ALL LOCK

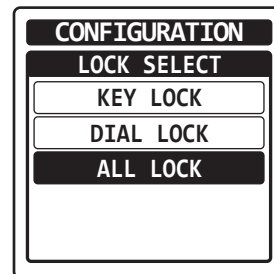

The setting will be determined and the display will return to the CONFIGURATION menu.

ADVANCED OPERATION

Activating the lock feature

- ❑ Press and hold the [**On**] key.

According to the setting of the lockout configuration, either of “KEY LOCK”, “DIAL LOCK”, or “ALL LOCK” will appear on the screen for 2 seconds and then the display will return to the previous screen.

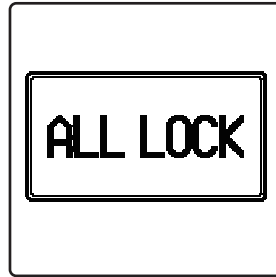
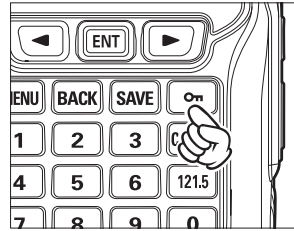

- ❑ While the **FTA-750/FTA-550** are locked, the controls with the **DIAL** selector knob and/or the keys except the **PTT** switch, the **POWER** switch, and the [121.5] key are disabled.

If the **DIAL** selector knob is rotated or any of the keys is pressed, either of “DIAL LOCK”, “KEY LOCK”, or “ALL LOCK” will appear on the screen for 2 seconds and then the display will return to the previous screen.

- ❑ To turn the lock feature off, press and hold the [**On**] key again. “UNLOCK” will appear on the screen for 2 seconds and then the display will return to the previous screen.

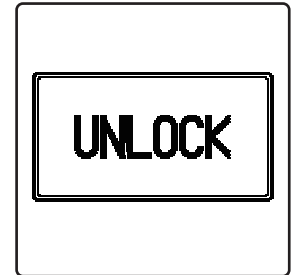

ADVANCED OPERATION

ANL Feature

For reduction of impulse noise, such as that produced by an engine's ignition system, the ANL (automatic noise limiter) feature may prove helpful.

To activate the ANL, select "ON" on the item "ANL" of the COMM SETUP menu in the SETUP mode.

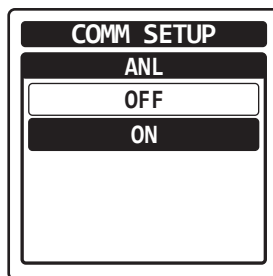
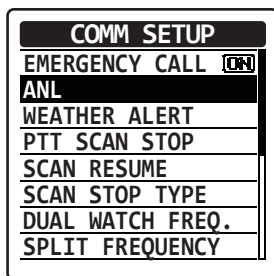

MEMORY OPERATION

The **FTA-750/FTA-550** provide 200 user-programmable memories which can hold sets of information about channels such as its channel frequency, position information, channel tag (name) up to 15 characters, and flag (marking for search refinement).

The stored channels can be assigned to the priority group which can be named with up to 10 characters.

The **FTA-750/FTA-550**'s memory system allows you to store, label, and recall channel frequencies you may use frequently.

Recalling the Memories

1. Press the [**MENU**] key to display the MENU screen.
2. Select "MEMORY" on the screen by pressing the [**◀**] or [**▶**] key, and then press the [**ENT**] key.

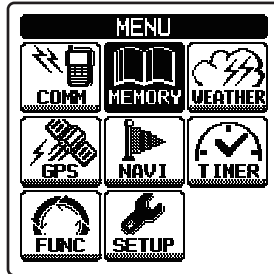

3. Select a group that the desired channel belongs to, by pressing the [**◀**] or [**▶**] key followed by the [**ENT**] key.

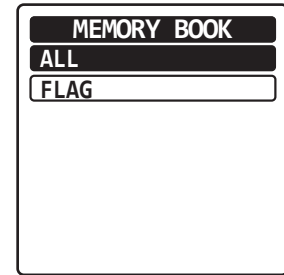

- The memory channels belong to either of the following groups.
 - ALL ... Group including all the memory channels
 - FLAG ... Group of memory channels you have set the item "Flag" to "Yes" when storing

MEMORY OPERATION

The frequency and tag name of the channel listed first, “**MR**” which indicates that the **FTA-750/FTA-550** are in the MR (memory recall) mode, and the group name selected in step 3 will appear on the upper field of the display.

- If the channel has the setting of flag, the “**▶**” icon will appear at the left side of its tag name.
- The list of memory channels will also appear below the VOL meter on the display. You may move to the list by pressing the [ENT] key, then select and tune to one of the channels in the list by pressing the [◀] or [▶] key followed by the [ENT] key.

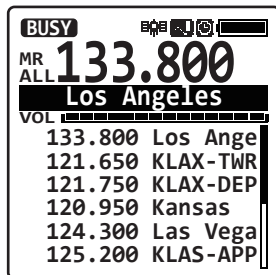

- If you have not yet stored any memory channel, a dialog box titled “No Address” will appear, which asks whether you want to make an entry. Select “YES” and press the [ENT] key to add memory channel entries.

See Page 52 for the detailed procedure of storing channel information.

- To exit the MR mode, press the [COMM] key.

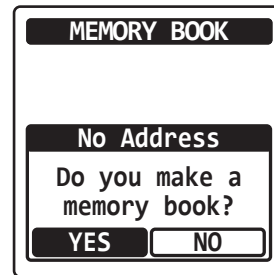

MEMORY OPERATION

Instant Storage

- Select a desired frequency in the COMM mode, then press the **[SAVE]** key. The frequency will be stored and a tag name automatically assigned will appear on the display.

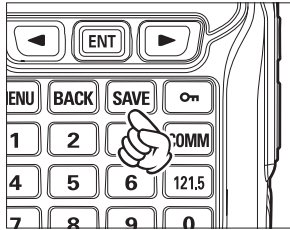

- If you want to customize the information to be stored, press and hold the **[SAVE]** key. The MEMORY BOOK form appears on the display, with the channel name (tag), frequency, flag, and position information (if exists) already filled.

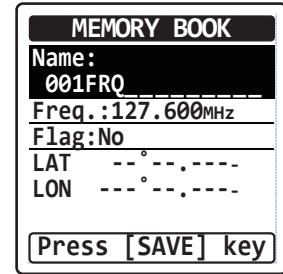

Press the [**◀**] or [**▶**] key to select the item, then press the **[ENT]** key.

Input letters and/or numerics with the keypad or the **DIAL** selector knob, or select a setting with the [**◀**] or [**▶**] key, then press the **[ENT]** key. After all the inputs or changes have been done, select “PRESS [SAVE] KEY” at the bottom of the display with the [**◀**] or [**▶**] key, then press the **[ENT]** key to store them into the memory.

MEMORY OPERATION

- ❑ Press the [**BACK**] key to cancel the changes or inputs.

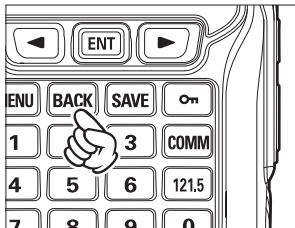

Note:

You cannot store weather channels to the memory by pressing the [**SAVE**] key during the WX mode.

Maintenance of the Memory

Adding new addresses, editing the stored information, and deleting the stored addresses are allowed through the SETUP mode.

Adding entries

1. Press the [**MENU**] key to display the MENU screen.
2. Select “SETUP” on the screen by pressing the [◀] or [▶] key, and then press the [**ENT**] key.

3. Select “MEMORY BOOK” on the screen by pressing the [◀] or [▶] key, and then press the [**ENT**] key.

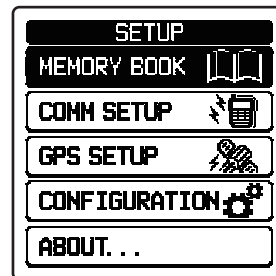

4. Select “ADD” by pressing the [◀] or [▶] key, and then press the [**ENT**] key.

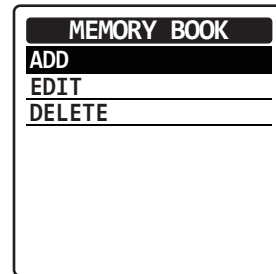

5. Select the item, input letters and/or numerics, select a setting, and store the changes in the same way as the instant storage described previously.

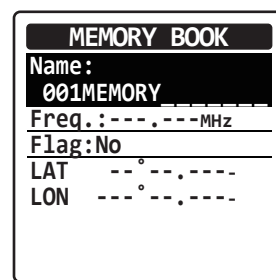

MEMORY OPERATION

Notes:

- You cannot skip the input of “Name” (channel tag).
- You must input either of “Freq.” (channel frequency) or “LAT” and “LON” (position information of the channel).

Editing the information

1. Press the [MENU] key to display the MENU screen.
2. Select “SETUP” on the screen by pressing the [◀] or [▶] key, and then press the [ENT] key.
3. Select “MEMORY BOOK” on the screen by pressing the [◀] or [▶] key, and then press the [ENT] key.
4. Select “EDIT” by pressing the [◀] or [▶] key, and then press the [ENT] key.

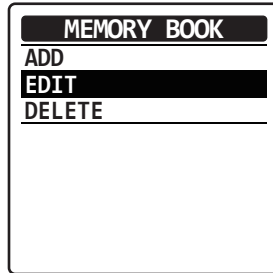

5. Press the [◀] or [▶] key to select the group including the entry you want to edit, then press the [ENT] key.

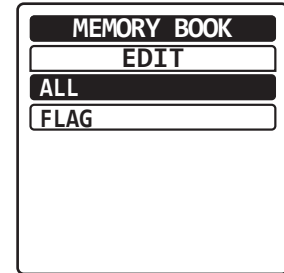

6. Press the [◀] or [▶] key to select the entry you want to edit, then press the [ENT] key.

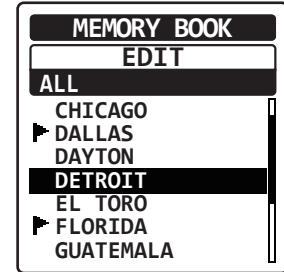

7. Select the item, input letters and/or numerics, select a setting, and then store the changes in the same way as the instant storage described previously.

MEMORY OPERATION

Deleting the memory

1. Press the **[MENU]** key to display the MENU screen.
2. Select "SETUP" on the screen by pressing the **[◀]** or **[▶]** key, and then press the **[ENT]** key.
3. Select "MEMORY BOOK" on the screen by pressing the **[◀]** or **[▶]** key, and then press the **[ENT]** key.
4. Select "DELETE" by pressing the **[◀]** or **[▶]** key, and then press the **[ENT]** key.

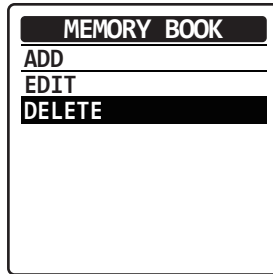

5. Press the **[◀]** or **[▶]** key to select the group including the entry you want to delete, then press the **[ENT]** key.

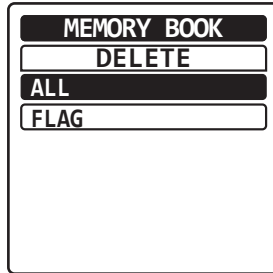

6. Press the **[◀]** or **[▶]** key to select the entry you want to delete, and then press the **[ENT]** key.

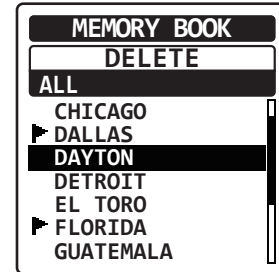

7. Select "OK?" on the screen by pressing the **[◀]** or **[▶]** key, and then press the **[ENT]** key.

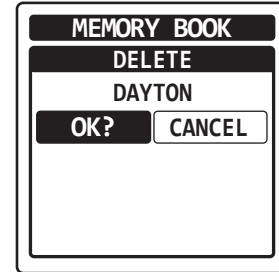

The display will return to the previous screen after the deletion of the entry from the memory.

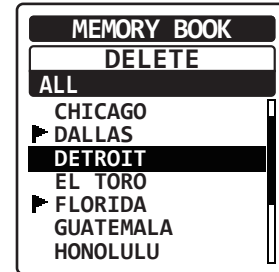

SCANNING OPERATION

The **FTA-750/FTA-550** allow you to scan active channels automatically in the COMM (COM band), MR, and WX modes. It pauses on signals encountered, so you can talk to the station(s) on that frequency if you like.

Scanning All Channels

1. Set the radio to the COMM mode.
2. Press the [**MENU**] key to display the MENU screen.
3. Select “FUNC” on the screen by pressing the [**◀**] or [**▶**] key, and then press the [**ENT**] key.
4. Select “SCAN” on the screen by pressing the [**◀**] or [**▶**] key, and then press the [**ENT**] key.

FUNCTION	
SCAN MEM	OFF
DUAL WATCH	OFF
SCAN	OFF
SPLIT	OFF
LOGGER	OFF

The scanning starts and the display returns to the COMM mode screen.

- The scanner searches signals from the lower frequency to higher.
- When the scanner encounters a signal, the scanning pauses and the radio remains on that channel until the signal disappears, and the frequency indication on the display blinks.
- After the signal disappears, the scanning resumes.
- To stop the scanning, press the **PTT** switch, or select “SCAN” again in the FUNCTION menu.

FUNCTION	
SCAN MEM	OFF
DUAL WATCH	OFF
SCAN	ON
SPLIT	OFF
LOGGER	OFF

Next time the scanning is activated, the search will start from the frequency at which the scanning was stopped last time.

SCANNING OPERATION

Note:

When you enable the alarm function at reception of the weather alert signal via the COMM SETUP menu in the SETUP mode, the last weather channel will be watched as the every second frequency during a scan.

Example: when the last weather channel is 162.4 MHz, the radio scans in the following order.

108.000 → 162.400 → 108.025 → 162.400 → 108.050 → 162.400 ...

The frequency of the last weather channel, however, will not be displayed until the scanner encounters the weather alert signal.

Scanning the Specified Channels

Among the memory and weather channels, you may scan only those on which you want to see if a signal exists.

Marking the channels

1. Set the radio to the MR or WX mode and tune to the channel that you want to be scanned.
2. Press the [MENU] key to display the MENU screen.
3. Select “FUNC” on the screen by pressing the [◀] or [▶] key, and then press the [ENT] key.

4. Select “SCAN MEM” on the screen by pressing the [◀] or [▶] key, and then press the [ENT] key.

FUNCTION	
SCAN MEM	OFF
DUAL WATCH	OFF
SCAN	OFF
SPLIT	OFF
LOGGER	OFF

The current channel is marked to be scanned and the “MEM” icon, which indicates that the channel is the target of scanning, will appear at the right side of the channel frequency when the display returns to the MR or WX mode screen.

BUSY	📶 🔊 📶 🔊 📶 🔊
MR	133.800 MEM
Los Angeles	
VOL	132.400 Las Vega

5. Repeat steps 1 to 4 above to mark other channels as well.

SCANNING OPERATION

Scanning the marked channels

- ❑ Set the radio to the MR or WX mode, then perform steps 2 to 4 of the section “Scanning All Channels” in the previous page.
The scanning starts and the display returns to the MR or WX mode screen.
- ❑ The **FTA-750/FTA-550** operate in the same way as that when scanning all channels described in the previous page, except that it searches a signal on the marked frequencies only.

Note:

When you enable the alarm function at reception of the weather alert signal via the COMM SETUP menu in the SETUP mode, the last weather channel will be watched as the every second channel during a scan.

Example: when the last weather channel is WX03, the radio scans in the following order.

MEM001 → WX03 → MEM002 → WX03 →
MEM003 → WX03 ...

The frequency of the last weather channel, however, will not be displayed until the scanner encounters the weather alert signal.

GPS FUNCTION (FTA-750 ONLY)

The **FTA-750** has an internal GPS reception unit to receive and display the position information at all times. The position information of your own as well as received stations can be memorized and utilized later for navigation.

Activating the GPS Unit

1. Press the [MENU] key to display the MENU screen.
2. Select “SETUP” on the screen by pressing the [◀] or [▶] key, and then press the [ENT] key.
3. Select “GPS SETUP” on the screen by pressing the [◀] or [▶] key, and then press the [ENT] key.

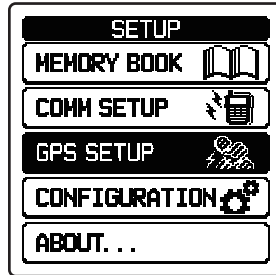

4. Select “GPS ON/OFF” on the screen by pressing the [◀] or [▶] key, and then press the [ENT] key.

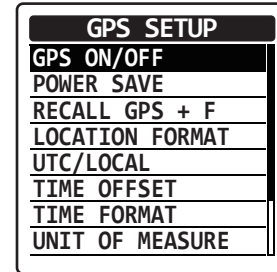

5. Select “ON” on the screen by pressing the [◀] or [▶] key, and then press the [ENT] key.

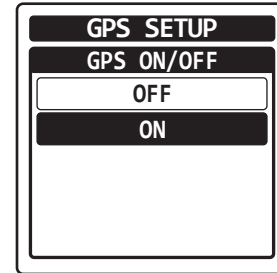

The GPS unit is set to ON and the display will return to the GPS SETUP menu.

The “GPS” icon will appear on the top of the display when returning to the screen of the COMM, MR, or other operation mode.

Notes:

- The GPS unit is set to ON by default.
- To reduce the power consumption, you are recommended to turn the GPS unit OFF if unnecessary.

GPS FUNCTION (FTA-750 ONLY)

Displaying the Position Information

You can choose the way to display the position information from three types; numerical, compass, and numerical with GPS status.

Notes:

- You may change the unit of displayed measurements via the SETUP mode.
- You may set the time area and offset via the SETUP mode.
- The position information will be displayed with the screen type you have selected last time before switching the operation mode or turning off the radio.

Numerical display

1. Press the [MENU] key to display the MENU screen.
2. Select “GPS” on the screen by pressing the [◀] or [▶] key, and then press the [ENT] key.

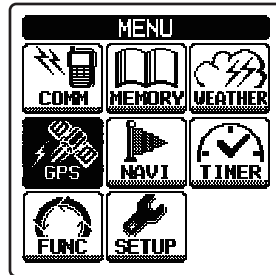

3. Select “GPS INFO” on the screen by pressing the [◀] or [▶] key, and then press the [ENT] key.

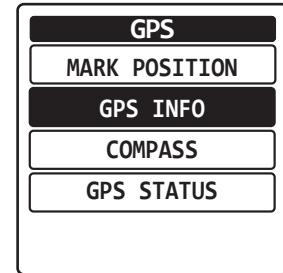

The latitude and longitude of your current position, COG (course over ground), SOG (speed over ground), altitude, and the date will be displayed below the VOL meter on the screen.



Note:

The power save operation of the GPS unit is disabled while displaying the position information.

GPS FUNCTION (FTA-750 ONLY)

Compass display

1. Press the **[MENU]** key to display the MENU screen.
2. Select “GPS” on the screen by pressing the **[◀]** or **[▶]** key, and then press the **[ENT]** key.
3. Select “COMPASS” on the screen by pressing the **[◀]** or **[▶]** key, and then press the **[ENT]** key.

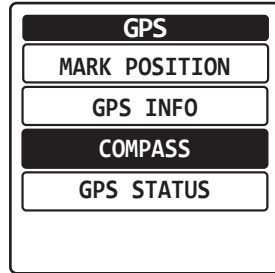

The compass with your traveling course up, COG (course over ground), SOG (speed over ground), altitude, and the date will be displayed below the VOL meter on the screen.

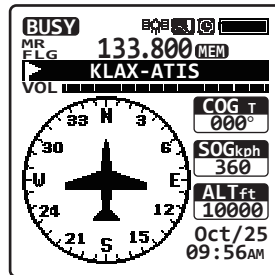

Note:

The power save operation of the GPS unit is disabled while displaying the position information.

Numerical display with GPS status

1. Press the **[MENU]** key to display the MENU screen.
2. Select “GPS” on the screen by pressing the **[◀]** or **[▶]** key, and then press the **[ENT]** key.
3. Select “GPS STATUS” on the screen by pressing the **[◀]** or **[▶]** key, and then press the **[ENT]** key.

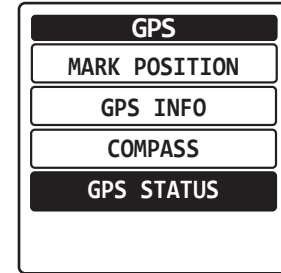

The latitude and longitude of your current position, a radar scope showing the position of captured GPS satellites, bars indicating the signal strength of captured GPS satellites, and the date will be displayed below the VOL meter on the screen.

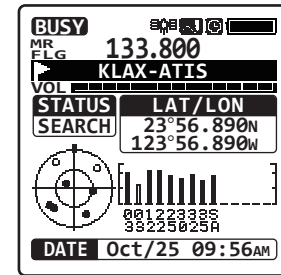

GPS FUNCTION (FTA-750 ONLY)

Memorizing the Position Information

You can save your position information at a certain point of time in the memory book of the radio.

1. Press the [**MENU**] key to display the MENU screen.
2. Select “GPS” on the screen by pressing the [**◀**] or [**▶**] key, and then press the [**ENT**] key.
3. Select “MARK POSI-TION” on the screen by pressing the [**◀**] or [**▶**] key, and then press the [**ENT**] key.

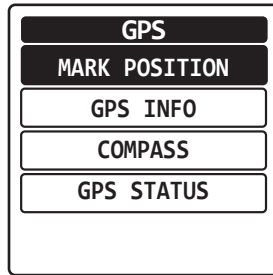

The MARK POSITION form appears on the display, with the name (tag), frequency, group tag, and current position information already filled.



- If you need no change to the items on the form, press the [**SAVE**] key. The position information will be stored into the memory and the display returns to the screen displayed before entering the menu mode.
- If you want to change or input either of the items in the form, press the [**◀**] or [**▶**] key to select the item, then press the [**ENT**] key. Input letters and/or numerics with the keypad or the **DIAL** selector knob, then press the [**ENT**] key. Press the [**SAVE**] key after all the inputs or changes have been done to store them into the memory.
- Press the [**BACK**] key to cancel the changes or inputs.

GPS FUNCTION (FTA-750 ONLY)

Recording the Position Information

The **FTA-750** includes a logger for position information that allows you to record your location at a regular interval.

1. Press the [**MENU**] key to display the MENU screen.
2. Select “FUNC” on the screen by pressing the [◀] or [▶] key, and then press the [**ENT**] key.
3. Select “LOGGER” on the screen by pressing the [◀] or [▶] key, and then press the [**ENT**] key.

FUNCTION	
SCAN MEM	OFF
DUAL WATCH	OFF
SCAN	OFF
SPLIT	OFF
LOGGER	OFF

The recording starts and the display returns to the previous screen with the “” icon on the top of the display.

- You may change the interval time of recording via the SETUP mode.

Notes:

- The power save operation of the GPS unit is disabled while the logger is activated.
- To utilize the records, connect the **FTA-750** to a PC and take the log data from the radio by using the PC Programming Software **YCE01** (the **YCE01** may be downloaded through the YAESU website).

Logger operation alert

- When the memory for log data becomes full, three beeps will sound and a warning message will be displayed.
Afterwards the logger does not operate until the log data in the memory are erased.
- When the logger cannot record for some reasons, three beeps will sound and a warning message will be displayed.
Afterwards the logger does not operate anymore.
- An error message will be displayed when the radio cannot erase the log data in the memory during the operation following the alert of memory full (see above) or in the SETUP mode (see Page 76).

WAYPOINT NAVIGATION (FTA-750 ONLY)

The navigation feature of the **FTA-750** is presented in a compass that helps you to figure out the destination and your traveling direction at a glance.

The destination can be selected from the memory channels and the list of points you have selected previously, or can be directly specified.

Notes:

- Be sure that the internal GPS unit has been activated before using the navigation.
- The navigation does not work when insufficient number of GPS satellites are captured to obtain your position.

Entering the Navigation (NAVI) Mode

- Select “NAVI” on the MENU screen by pressing the [◀] or [▶] key, and then press the [ENT] key.

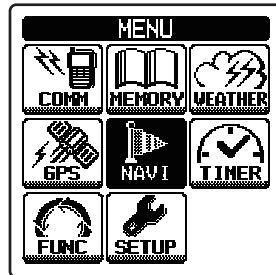

The compass screen including the destination you have selected last time will be displayed if you did not reach there before switching the operation mode or turning off the radio.

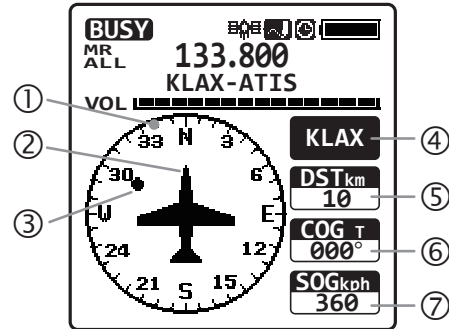

- ① Compass rose
 - ② Course indicator
 - ③ Destination indicator
 - ④ Tag name of the destination
 - ⑤ DST (distance)
 - ⑥ COG (course over ground)
 - ⑦ SOG (speed over ground)
- The compass rose rotates to display the travelling course up.

WAYPOINT NAVIGATION (FTA-750 ONLY)

Setting the Destination

When the radio enters the NAVI mode for the first time, or if you have reached the destination during the NAVI mode last time, the NAVI menu will be displayed after selecting “NAVI” on the MENU screen.

Selecting from the memory

1. Select “MEMORY” on the NAVI menu by pressing the [◀] or [▶] key, and then press the [ENT] key.

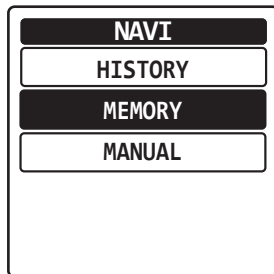

2. Select a group that the desired station is assigned by pressing the [◀] or [▶] key, and then press the [ENT] key.

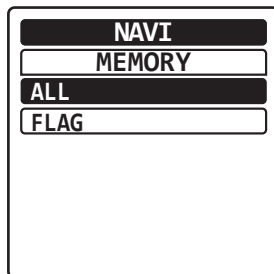

3. Select a station from the station list of the group by pressing the [◀] or [▶] key, and then press the [ENT] key.

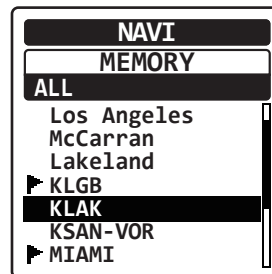

The information of the selected station will appear with the reversed “GOTO” displayed at the bottom.

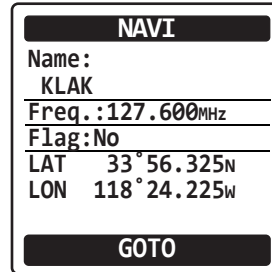

4. Press the [ENT] key. The compass screen will be displayed.

Selecting from the history

- Select “History” on the NAVI menu, and then select and set the desired station in the same way as steps 3 and 4 above.

WAYPOINT NAVIGATION (FTA-750 ONLY)

Specifying the position directly

1. Select “MANUAL” on the NAVI menu by pressing the [◀] or [▶] key, and then press the [ENT] key.
2. Select the “LAT” and “LON” field by pressing the [◀] or [▶] key, and then press the [ENT] key.

NAVI
HISTORY
MEMORY
MANUAL

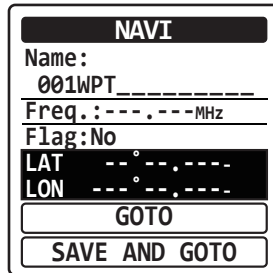

NAVI
Name:
001WPT
Freq.: ---.---MHz
Flag: No
LAT --°--'---
LON ---°--'---
GOTO
SAVE AND GOTO

3. Input numerics and letters with the keypad or the **DIAL** selector knob, then press the [ENT] key.

The cursor will move to the next digit of the position information.

NAVI
POSITION
LAT -°--'---
LON ---°--'---
FINISH

4. Repeat step 3 to input all digits of the position information.

If you want to correct a mistake, press the [◀] or [▶] key to move the cursor to the digit you want to change, then perform step 3 again.

5. Select “FINISH” by pressing the [◀] or [▶] key, and then press the [ENT] key.

The input information will appear with the reversed “GOTO” displayed at the bottom.

NAVI
Name:
001WPT
Freq.: ---.---MHz
Flag: No
LAT 33°56.325N
LON 118°24.225W
GOTO
SAVE AND GOTO

6. Press the [ENT] key.
The compass screen will be displayed.

WAYPOINT NAVIGATION (FTA-750 ONLY)

- You may store the input information to the memory of the radio by selecting “SAVE AND GOTO” before step 6 above.
- You may give a custom tag name to the input information and assign it to a desired group before step 6, in the same way as steps 2 to 5.

SETUP MODE

Note:

We do not recommend that any of the default settings be changed until you are thoroughly familiar with the operation of the **FTA-750/FTA-550**.

Basic Operation

1. Press the **[MENU]** key to display the MENU screen.

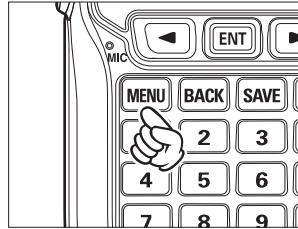

2. Select "SETUP" on the MENU screen by pressing the [**◀**] or [**▶**] key, and then press the **[ENT]** key.

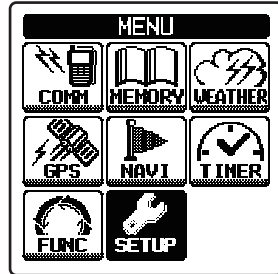

3. Select the item on the SETUP menu by pressing the [**◀**] or [**▶**] key, and then press the **[ENT]** key.

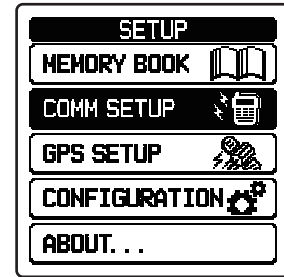

4. Select the item you wish to view and/or change the settings by pressing the [**◀**] or [**▶**] key, and then press the **[ENT]** key.

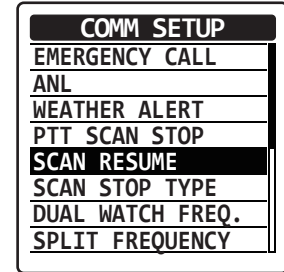

5. Enter or select settings on the screen dedicated to each item, and then press the **[ENT]** key to determine the new settings.

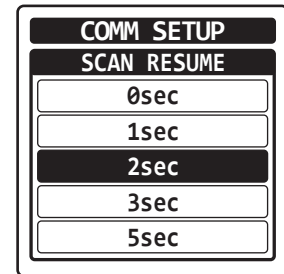

SETUP MODE

Menu items

○ MEMORY BOOK

You may store the frequencies or positions with a tag name to the memory of the radio, and maintain the stored entries.

○ COMM SETUP

You may set and adjust the operations of the radio in the COMM mode.

○ GPS SETUP (FTA-750 only)

You may set and adjust the operations of the radio in the GPS mode.

○ CONFIGURATION

You may set and adjust the various conditions of the radio.

○ ABOUT...

You may confirm the version of the software currently operating on the radio.

Maintenance of the Memory

See Pages 52 to 54 for details.

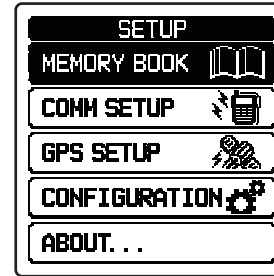

SETUP MODE

Setting of the COMM Mode Operation

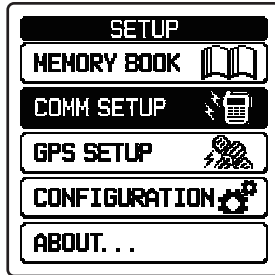

Turning on/off the emergency call

You may enable or disable the quick access to the 121.500 MHz emergency frequency (see also Page 21).

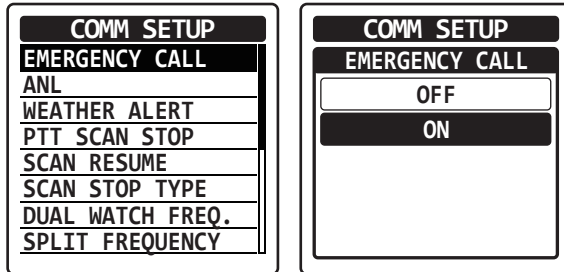

Turning on/off the automatic noise limiter

See Page 48 for details.

Turning on/off the weather alert

You may enable or disable the alarm function when receiving the weather alert signal (see also Page 36).

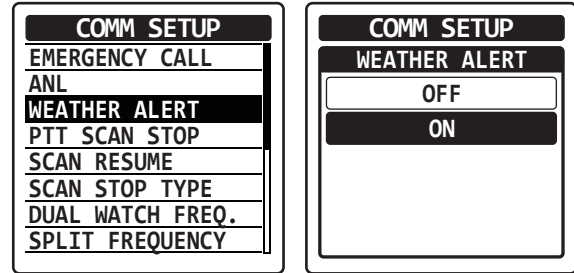

Turning on/off the scan stop with the PTT

You may lock out the **PTT** switch during the scan operation (see also Page 55).

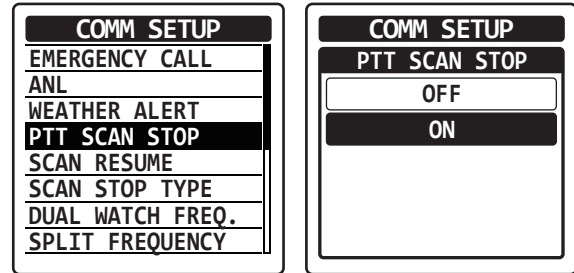

SETUP MODE

Setting the scan resume time

You may select a waiting time till the resuming of scan after the encountered signal disappears (see also Page 55).

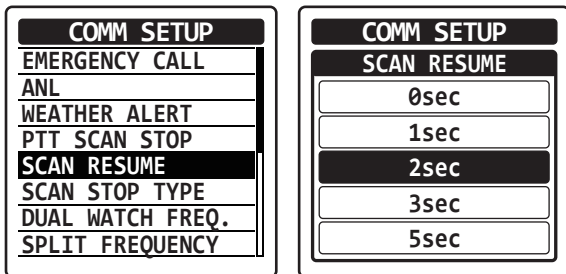

Setting the operation after stopping a scan

You may select either of the operations below when encountering a signal during a scan (see also Page 55).

BUSY STOP ... Stays at the frequency and will not resume the scan

5sec STOP ... Stays at the frequency for 5 seconds and then resume the scan

10sec STOP ... Stays at the frequency for 10 seconds and then resume the scan

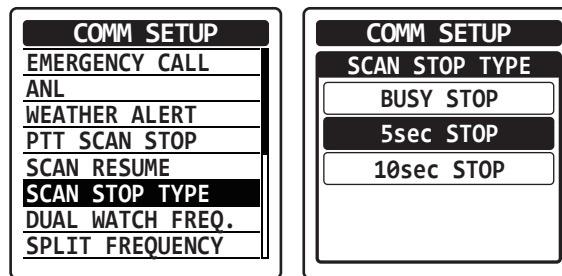

SETUP MODE

Setting the polled frequency for dual watch
See Page 37 for details.

Setting the transmit frequency during the
NAV band reception
See Page 33 for details.

Setting the frequency step for tuning
You may select the frequency rate for one click of the
DIAL selector knob (see also Page 19).

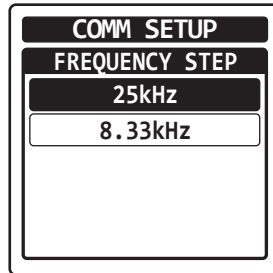
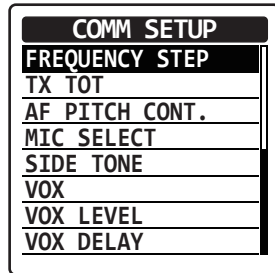

Setting the time-out timer for transmission
See Page 43 for details.

Setting the audio filter of the receiver
You may select the operation of the audio filter from the
following 4 types.

NORMAL ... No filtering

LOW CUT ... Cuts off the lower range of sound

HIGH CUT ... Cuts off the higher range of sound

HIGH AND LOW CUT ... Cuts off the higher and
lower ranges of sound

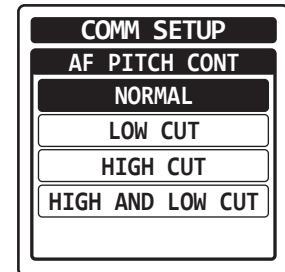
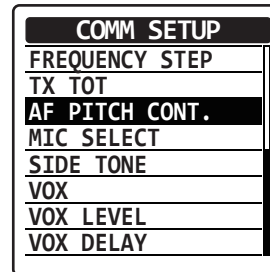

SETUP MODE

Setting the microphone configuration

See Page 44 for details.

Setting the side tone operation

See Page 45 for details.

Turning on/off the VOX operation

See Page 44 for details.

Setting the sensitivity of the VOX system

See Page 45 for details.

Setting the sensing time of the VOX system

See Page 45 for details.

Setting of the GPS Mode Operation (FTA-750 Only)

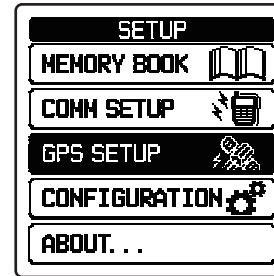

Turning on/off the internal GPS unit
See Page 58 for details.

SETUP MODE

Setting the power save operation of the internal GPS unit

You may select an interval time of periodical operation of the GPS unit to reduce battery consumption (see also Pages 59, 60, 62).

OFF ... Operates all the time

AUTO ... Sleeps until a GPS signal is received or the radio enters the GPS or NAVI mode

50% ... Sleeps for 3 sec after 3 sec operation

75% ... Sleeps for 9 sec after 3 sec operation

90% ... Sleeps for 27 sec after 3 sec operation

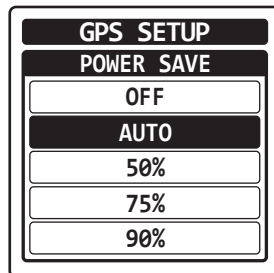
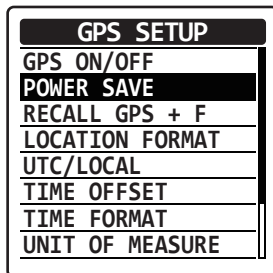

Turning on/off the recall of the frequency during the NAVI mode

You may tune the radio to the frequency of the marked position set as the destination of the waypoint navigation, if the position has been saved with its frequency.

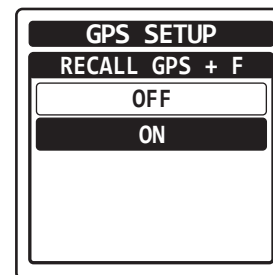
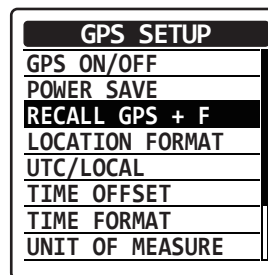

SETUP MODE

Setting the notation format of location

You may select the coordinate system for position information to be shown on the display (see also Page 59).

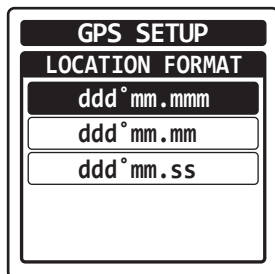
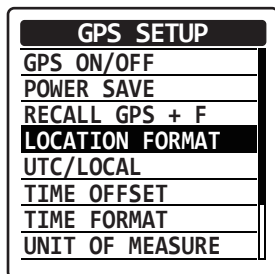

Setting the time offset

You must set the time offset of your current area when using the local time (see also Page 59).

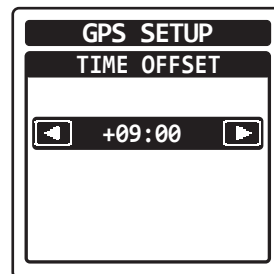
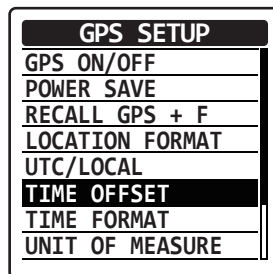

Setting the time area

You may select either of the UTC (universal time coordinated) time or local time to be shown on the display (see also Page 59).

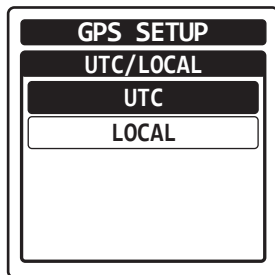
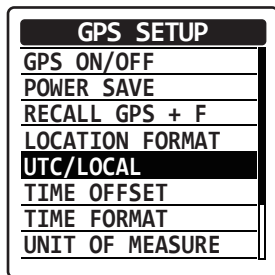

Setting the notation format of time

You may select either of the 24-hour or 12-hour notation of time to be shown on the display (see also Page 59).

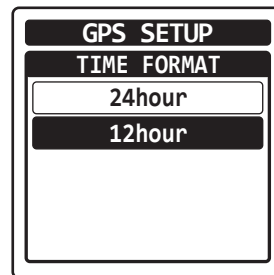
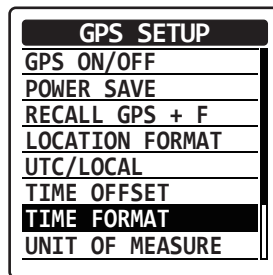

SETUP MODE

Setting the unit of measurement

You may select the unit of speed, distance, and altitude to be shown on the display (see also Page 59).

GPS SETUP	
GPS ON/OFF	
POWER SAVE	
RECALL GPS + F	
LOCATION FORMAT	
UTC/LOCAL	
TIME OFFSET	
TIME FORMAT	
UNIT OF MEASURE	

GPS SETUP	
UNIT OF MEASURE	
SPEED	kts
DISTANCE	sm
ALTITUDE	ft

GPS SETUP	
SPEED	
knots	
mile/h	
km/h	

GPS SETUP	
UNIT OF MEASURE	
SPEED	kts
DISTANCE	sm
ALTITUDE	ft

GPS SETUP	
DISTANCE	
statute mile	
nautical mile	
km	

GPS SETUP	
UNIT OF MEASURE	
SPEED	kts
DISTANCE	sm
ALTITUDE	ft

GPS SETUP	
ALTITUDE	
feet	
meter	

SETUP MODE

Turning on/off the pinning

You may enable or disable the update of the position information when you have stayed at a location for a certain period of time.

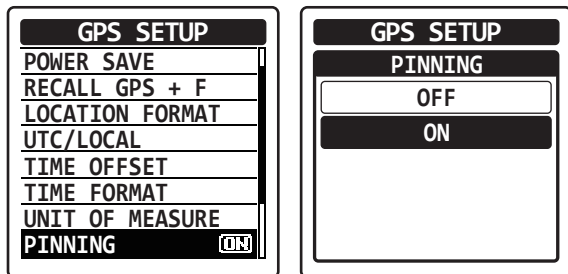

Setting the interval time of logging

You may select a time rate for recording of the position information obtained from the GPS (see also Page 62).

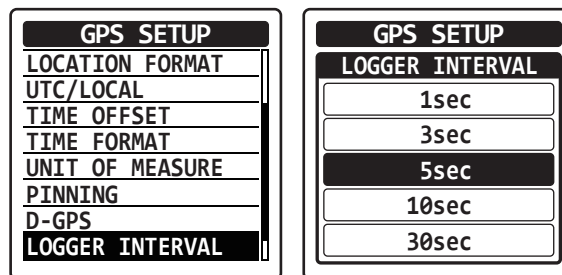

Turning on/off the differential GPS feature

You may use the SBAS (satellite-based augmentation system) while obtaining the position information.

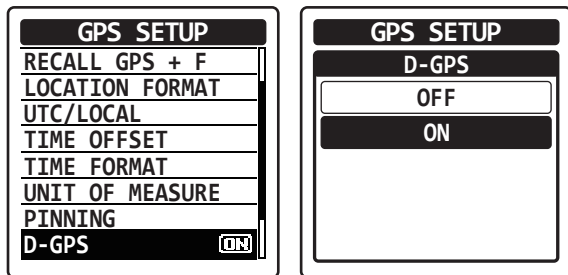

Erasing the log

You may delete the records of the position information obtained from the GPS (see also Page 62).

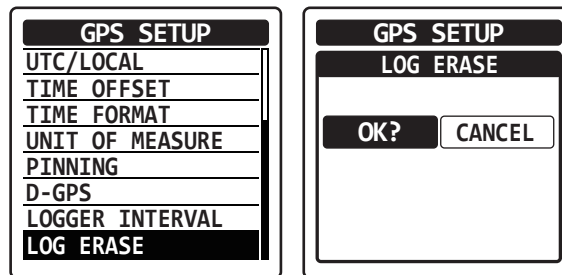

SETUP MODE

Setting of the Operation and Configuration of the Radio

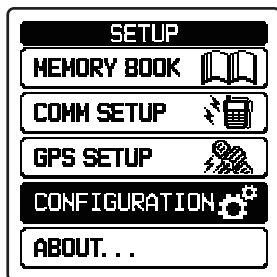

Setting the brightness of the display

You may adjust the dimmer in 5 levels.

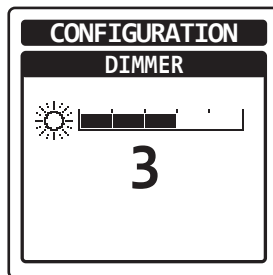
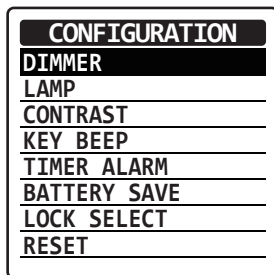

Setting the lamp of the display

You may select the operation of the display lighting from the following 4 types.

- OFF ... No lighting at any time
- CONTINUOUS ... Lights at all time
- KEY ON ... Lights for 5 seconds only when any key is pressed
- EXT PO/KEY ... Lights for 5 seconds only when any key is pressed, or lights at all time when the power is supplied through the **EXT DC** jack

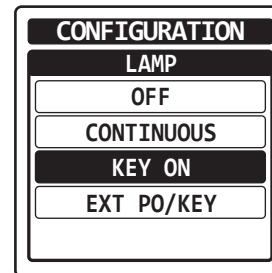
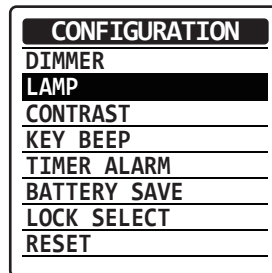

SETUP MODE

Setting the contrast of the display

You may adjust the contrast in 30 levels.

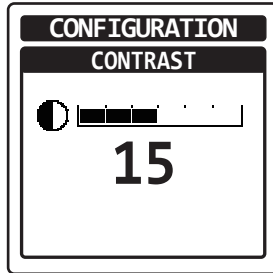
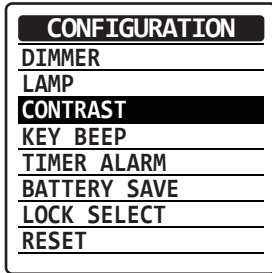

Turning on/off the timer alarm

See Page 42 for details.

Setting the power save operation

See Page 43 for details.

Setting the lockout configuration

See Page 46 for details.

Setting the loudness of key beeps

You may adjust the loudness in 5 levels.

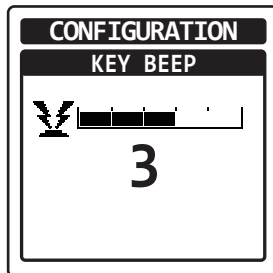
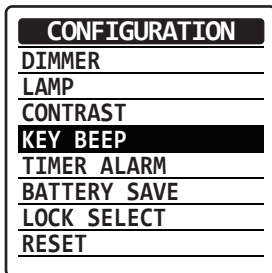

SETUP MODE

Resetting the radio

You may initialize the memories and settings of the menu categories independently or all at once (see also Pages 25 and 26).

FUNCTION ... Initializes the on/off settings in the FUNCTION menu

MEMORY ... Clears the entries in the memory

COMM & GPS ... Initializes the settings in the COMM SETUP and GPS SETUP menus

CONFIGURATION ... Initializes the settings in the CONFIGURATION menu

FACTORY ... Resets the radio to factory default

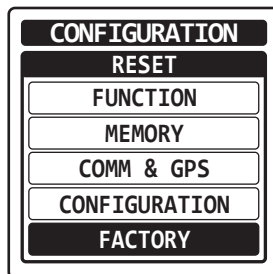
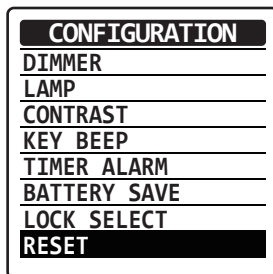

About the Radio

You may confirm the version of the software currently operating on the radio.

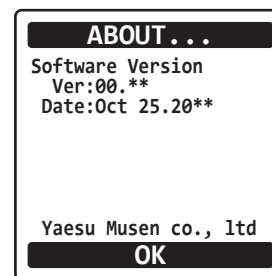
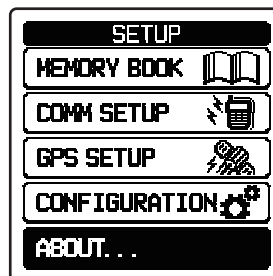

SETUP MODE

Summary of the SETUP Menu

MEMORY BOOK

Item	Description	Default Value
ADD	Adding new channels or destinations	-
EDIT	Editing the stored information	-
DELETE	Deleting the stored channel or destination	-

COMM SETUP

Item	Description	Default Value
EMERGENCY CALL	Turning on/off the emergency call	ON
ANL	Turning on/off the automatic noise limiter	OFF
WEATHER ALERT	Turning on/off the weather alert	OFF
PTT SCAN STOP	Turning on/off the scan stop with the PTT	ON
SCAN RESUME	Setting the scan resume time	3 sec
SCAN STOP TYPE	Setting the operation after stopping a scan	BUSY STOP
DUAL WATCH FREQ.	Setting the polled frequency for dual watch	-
SPLIT FREQUENCY	Setting the transmit frequency during the NAV band reception	-

Item	Description	Default Value
FREQUENCY STEP	Setting the frequency step for tuning	25 kHz
TX TOT	Setting the time-out timer for transmission	5 min
AF PITCH CONT.	Setting the audio filter of the receiver	NORMAL
MIC SELECT	Setting the microphone configuration	INT MIC
SIDE TONE	Setting the side tone operation	OFF
VOX	Turning on/off the VOX operation	OFF
VOX LEVEL	Setting the sensitivity of the VOX system	LEVEL 2
VOX DELAY	Setting the sensing time of the VOX system	1.5 sec

SETUP MODE

GPS SETUP (FTA-750 only)

Item	Description	Default Value
GPS ON/OFF	Turning on/off the internal GPS unit	ON
POWER SAVE	Setting the power save operation of the internal GPS unit	AUTO
RECALL GPS + F	Turning on/off the recall of the frequency during the NAVI mode	OFF
LOCATION FORMAT	Setting the notation format of location	ddd°mm. mmm
UTC/LOCAL	Setting the time area	UTC
TIME OFFSET	Setting the time offset	0:00
TIME FORMAT	Setting the notation format of time	24 hour
UNIT OF MEASURE	SPEED	Setting the unit of measurement
	DISTANCE	
	ALTITUDE	
		knots
		nautical mile
		feet
PINNING	Turning on/off the pinning	OFF
D-GPS	Turning on/off the differential GPS feature	ON
LOGGER INTERVAL	Setting the interval time of logging	5 sec
LOG ERASE	Erasing the log	-

CONFIGURATION

Item	Description	Default Value
DIMMER	Setting the brightness of the display	5
LAMP	Setting the lamp of the display	EXT PO/KEY
CONTRAST	Setting the contrast of the display	15
KEY BEEP	Setting the loudness of key beeps	3
TIMER ALARM	Turning on/off the timer alarm	ON
BATTERY SAVER	Setting the power save operation	50%
LOCK SELECT	Setting the lockout configuration	ALL LOCK
RESET	Resetting the radio	-

ABOUT...

Item	Description	Default Value
-	Confirming the version of the software	-

SPECIFICATIONS

General

Frequency Range:	TX: 118.000 to 136.975 MHz RX: 108.000 to 136.975 MHz (NAV and COM bands) 161.650 to 163.275 MHz (Weather Channels) 329.150 to 335.000 MHz (Glide slope; FTA-750 only)
Channel Spacing:	25 kHz/8.33 kHz
Emission Type:	TX: AM RX: AM & FM (FM: for receiving the Weather Channels)
Supply Voltage:	6.0 to 9.5 VDC
Current Consumption (approx.):	300 μ A (power off), 70 mA (battery saver on, saver ratio 50%) 80 mA (squelch on), 300 mA (receive), 0.9 A (transmit 1.5 W Carrier)
Temperature Range:	+14 °F to + 140 °F (-10 °C to +60 °C)
Case Size (W x H x D):	2.4 x 5.2 x 1.3 inches (62 x 133 x 34 mm) with SBR-12LI
Weight (approx.):	14.5 oz (410 g) with SBR-12LI, antenna and belt clip

Receiver

Circuit Type:	Double-conversion superheterodyne
IFs:	47.25 MHz & 450 kHz
Sensitivity:	Better than 0.8 μ V (for 6 dB S/N with 1 kHz, 30 % modulation)
Selectivity:	>8 kHz/-6 dB
Adjacent CH. Selectivity:	<25 kHz/-60 dB
AF Output (@7.4 V):	0.8 W @ 16 Ohms, 10 % THD

SPECIFICATIONS

Transmitter

Power Output (@ 7.4 V):	5.0 W (PEP), 1.5 W (Carrier Power)
Frequency Stability:	Better than ± 1 ppm (+14 °F to + 140 °F [-10 °C to +60 °C])
Modulation System:	Low Level Amplitude Modulation
Spurious Emission:	>70 dB below carrier
Int. Microphone Type:	Condenser
Ext. Mic. Impedance:	150 Ohms

GPS Unit (FTA-750 only)

Receiver Channels	66 Channels
Sensitivity	Less than -147 dBm
Time to First Fix	1 minute typical (@ Cold Start) 5 seconds typical (@ Hot Start)
Geodetic Datum	WGS84

Specifications are subject to change without notice or obligation.

TROUBLESHOOTING FOR HEADSET CONNECTION

Question	Answer
When connecting the SCU-15 headset adapter cable between the radio and a headset, the “ TX ” icon appears on the display and the radio cannot be operated.	This happens when the plug on the SCU-15 headset adapter cable is simply inserted into the MIC/SP jack. To make proper contacts within the radio, the plug must be pushed all the way in the MIC/SP jack and be fixed with the two screws.
Can I purchase the optional PTT Switch from Yaesu?	Contact your Aviation dealer for details on purchasing an aftermarket Push-To-Talk switch.
Will my headset work with this radio?	The SCU-15 headset adapter cable is made to operate with most headsets; however to be concretely sure to check with the headset manufacturer providing the wiring shown below. Please confirm the connections and connector sizes are correct.

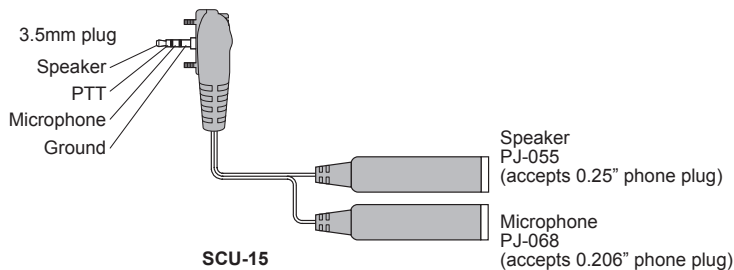

Headset specification requirements for SCU-15

Earphone (speaker) impedance: 8 Ω or above

Microphone impedance: 150 Ω \pm 20%

PTT pressed: Ground

PTT not pressed: Open

NOTE

NOTE

Quick Reference

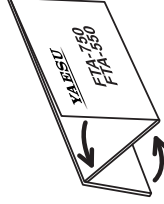
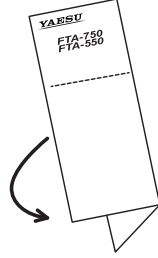
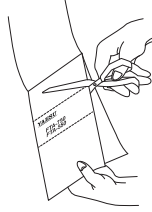

(Cut Here)

YAESU

FTA-750 Spirit *FTA-550 Pro-x*

Quick Reference Card

YAESU MUSEN CO., LTD.

Recalling the Previous Frequencies

1. In the COMM mode screen, press the [ENT] key.
2. Press the [◀] or [▶] key to select the desired channel from the list, then press the [ENT] key.

Recalling the Memory Channels

1. Press the [MENU] key to display the MENU screen.
2. Press the [◀] or [▶] key to select "MEMORY", then press the [ENT] key.

3. Press the [◀] or [▶] key to select a group including the desired channel from the list, then press the [ENT] key.
4. After switching to the MR mode screen, press the [ENT] key.
5. Press the [◀] or [▶] key to select the desired channel from the list, then press the [ENT] key.

Saving the Frequency to Memory

1. In the COMM mode screen, set the frequency to be stored with the DIAL selector knob or the keypad.
2. Press the [SAVE] key.
3. To save the data with a specific name or attribute, press and hold the [SAVE] key.

Receiving the Weather Channels

1. Press the [MENU] key to display the MENU screen.
2. Press the [◀] or [▶] key to select "WEATHER", then press the [ENT] key.
3. Press the [◀] or [▶] key to select the desired channel from the list.
4. Press the [ENT] key.

Locking the Dial and Keys

Press and hold the [On] key.
Press and hold the [On] key again to unlock.

Selecting the Operation Mode

1. Press the [MENU] key to display the MENU screen.
2. Press the [◀] or [▶] key to select the mode, then press the [ENT] key.
3. To return to the screen displayed before pressing the [MENU] key, press the [BACK] key several times.

OBS Setting on the VOR CDI Screen

1. In the VOR CDI on the NAV band screen, press the [◀] or [▶] key to select "OBS".
2. Press the appropriate keys on the keypad to enter numbers, or rotate the DIAL selector knob to select a degree.

GPS Activation (FTA-750 only)

1. Press the [MENU] key to display the MENU screen.
2. Press the [▶] or [▶] key to select "SETUP", then press the [ENT] key.
3. Select "GPS SETUP", then press the [ENT] key.
4. Select "GPS ON/OFF", then press the [ENT] key.
5. Select "ON", then press the [ENT] key.
6. To return to the screen displayed before pressing the [MENU] key, press the [BACK] key several times.

Waypoint Navigation (FTA-750 only)

1. Press the [MENU] key to display the MENU screen.
2. Press the [▶] or [▶] key to select "NAV", then press the [ENT] key.
3. Press the [▶] or [▶] key to select "HISTORY" or "MEMORY", then press the [ENT] key.
4. Press the [▶] or [▶] key to select the desired destination from the list, then press the [ENT] key.
3. Press the [ENT] key with "GOTO" reversed.

Entering and Editing Characters

1. Rotate the DIAL selector knob to select alphabets and numbers, then press the [ENT] key to set the character.
2. Press the appropriate keys on the keypad to enter numbers.
3. Press the [▶] or [▶] key to move the cursor.
4. Press the [BACK] key to delete one character.
5. Press and hold the [BACK] key to clear all the characters in the input field.

Under Industry Canada regulations, this radio transmitter may only operate using an antenna of a type and maximum (or lesser) gain approved for the transmitter by Industry Canada. To reduce potential radio interference to other users, the antenna type and its gain should be so chosen that the equivalent isotropically radiated power (e.i.r.p.) is not more than that necessary for successful communication.

Conformément à la réglementation d'Industrie Canada, le présent émetteur radio peut fonctionner avec une antenne d'un type et d'un gain maximal (ou inférieur) approuvé pour l'émetteur par Industrie Canada. Dans le but de réduire les risques de brouillage radioélectrique à l'intention des autres utilisateurs, il faut choisir le type d'antenne et son gain de sorte que la puissance isotrope rayonnée équivalente (p.i.r.e.) ne dépasse pas l'intensité nécessaire à l'établissement d'une communication satisfaisante.

This radio transmitter (identify the device by certification number, or model number if Category II) has been approved by Industry Canada to operate with the antenna types listed below with the maximum permissible gain and required antenna impedance for each antenna type indicated. Antenna types not included in this list, having a gain greater than the maximum gain indicated for that type, are strictly prohibited for use with this device.

Le présent émetteur radio (identifier le dispositif par son numéro de certification ou son numéro de modèle s'il fait partie du matériel de catégorie I) a été approuvé par Industrie Canada pour fonctionner avec les types d'antenne énumérés ci-dessous et ayant un gain admissible maximal et l'impédance requise pour chaque type d'antenne. Les types d'antenne non inclus dans cette liste, ou dont le gain est supérieur au gain maximal indiqué, sont strictement interdits pour l'exploitation de l'émetteur.

Part 15.21: Changes or modifications to this device not expressly approved by YAESU MUSEN could void the user's authorization to operate this device.

YAESU

YAESU MUSEN CO., LTD.

Tennozu Parkside Building
2-5-8 Higashi-Shinagawa, Shinagawa-ku, Tokyo
140-0002 Japan

YAESU USA

6125 Phyllis Drive, Cypress, CA 90630, U.S.A.

YAESU UK

Unit 12, Sun Valley Business Park, Winnall Close
Winchester, Hampshire, SO23 0LB, U.K.

YAESU HK

Unit 2002, 20/F, 9 Chong Yip Street,
Kwun Tong, Kowloon, Hong Kong

1402L-00

Copyright 2014

YAESU MUSEN CO., LTD.

All rights reserved.

No portion of this manual may be
reproduced without the permission of
YAESU MUSEN CO., LTD.

Printed in Japan

